



SGS[®] PLUS

Professional Power Tools

2024
\$UBAT



X-TECH

BRUSHLESS MOTOR

20V **MAX**
LITHIUM-ION
4.0Ah

Fiyat Listesi

www.sgstools.com.tr





1980 yılında Selahattin ÖZTÜRK tarafından kurulan firmamız hoşgörü ve saygı çerçevesi içerisinde büyük bir dikkat, özen ve dürüstlikle sizlere hizmet vermiştir.

SGS EL ALETLERİ günümüzün ilerleyen teknolojisi ile birlikte her geçen gün hızla büyüyerek 27.000m² kapalı 10.000m² açık toplam 37.000m² alanda üretim yapmaktadır. 1600'den fazla ürün çeşidi ile, 60 Ana Bayi, 650 Tali Bayi ve 62 Ülkeye İhracat yapmanın gururu ile, el aletleri sektöründe tercih edilen bir firma haline gelmiştir. Gerek Ar-Ge, gerek üretim tesislerimizdeki işinin ehli (**Usta**) larımız ve teknik ekibimiz hızlı, girişimci ve geliştirici yeni özgün fikirlerle üretime hiç ara vermeden devam etmektedir.

Yurtiçinde ve yurtdışında çalışmalarını ile hedefi her zaman kendini ve müşterilerini şaşırtmak olan firmamız, en son yeniliklerle sizlere daha iyi hizmet vermeyi amaçlamaktadır. İnanıyoruz ki, sizde çok sayıdaki değerli müşterilerimiz arasında yerinizi alacaksınız.

Profesyonel hizmet ve kadrosu ile 1980 yılından bu yana pek çok konuda üstün hizmet ve performans sağlayan firmamız siz değerli müşterilerimize **2024 Fiyat Listemizi** sunarız.

Saygılarımızla
SGS EL ALETLERİ
SAN.TİC.LTD.ŞTİ.

Akülü ve Elektrikli El Aletleri

6-18
SAYFA



Seramik Makineleri

22-23
SAYFA



Seramik Uygulama Ekipmanları

23-27
SAYFA



Alçı ve Sıvacı Uygulama Ekipmanları

28
SAYFA



Alçı ve Sıvacı Uygulama Ekipmanları

29-31
SAYFA



Boyacı ve Sıvacı Temizlik Ekipmanları

31-37
SAYFA



Aşındırıcı - Kesici Polisaj Ekipmanları

40-46
SAYFA



Yapı Kimyasalları ve Ekipmanları

50-56
SAYFA



Bant Çeşitleri

58-62
SAYFA



İş Güvenlik Ekipmanları

64-66
SAYFA



Kilit Çeşitleri ve Posta Kutuları

68-69
SAYFA



Boru Kaynak Makineleri ve Ekipmanları

72-73
SAYFA



Elektrik Ekipmanları

76-80
SAYFA



EL Aletleri Şalımo Setleri

82-88
SAYFA



Tornavida ve Setleri

90-92
SAYFA



Bahçe Ekipmanları ve Testere

94-100
SAYFA



Bağlantı Ekipmanları Kablo Kanalı Menfez

102-105
SAYFA



Matkap Uçları ve Pañç setleri

108-120
SAYFA





X-TECH



20V MAX Li-ion

ONE BATTERY MAX POWER
TEK BATARYA MAKSİMUM GÜÇ



SGS[®] PLUS

Professional Power Tools

BRUSHLESS
MOTOR



KÖMÜRSÜZ MOTOR
HIGH ENERGY EFFICIENCY
Yüksek Enerji Verimliliği
Daha Uzun Kullanım Ömrü

X-TECH



%50 Daha Fazla
Çalışma Süresi

Longer Running Time And Longer Life Span



Darbeli Matkap Seti

HI-TECH
20V
MAX 1.5Ah

LITHIUM-ION BATTERY

2x
BATARYA
74\$
SGS5248

Koli 10 Adet

35
Nm Tork

25+3 tork ayarı

Auto-Lock
Anahtarsız
Mandren
3X Üç Fonksiyonlu
Yüksek Güç
DARBELİ MATKAP
MATKAP - VIDALAMA

Akü kapasitesi	20V-1.5Ah-Li-ion
Hız - RPM	0-450/1500 d/dk
Darbe Oranı	0-22000bpm
Tork gücü	35 Nm / 2 Vites
Tork Seviyesi	21+3
Şarj süresi	60 dakika
Mandren Aralığı	0,8-10mm



BATARYASIZ

20 Volt Darbeli Matkap
Batarya ve şarj ünitesi opsiyoneldir.
33\$
SGS5247B

Matkap Seti

HI-TECH
20V
MAX 1.5Ah

LITHIUM-ION BATTERY

2x
BATARYA
69\$
SGS5249

Koli 10 Adet

35
Nm Tork

25+3 tork ayarı

Auto-Lock
Anahtarsız
Mandren
2X İki Fonksiyonlu
Yüksek Güç
MATKAP
VIDALAMA

Akü kapasitesi	20V-1.5Ah-Li-ion
Hız - RPM	0-450/1500 d/dk
Tork gücü	35 Nm / 2 Vites
Tork Seviyesi	21+3
Şarj süresi	60 dakika
Mandren Aralığı	0,8-10mm



BATARYASIZ

20 Volt Matkap
Batarya ve şarj ünitesi opsiyoneldir.
28\$
SGS5249B

Darbeli Matkap Seti

X-TECH
BRUSHLESS MOTOR
KÖMÜRSÜZ MOTOR
20V
MAX 2.0Ah

LITHIUM-ION BATTERY

2x
BATARYA
119\$
SGS5530

Koli 5 Adet

45
Nm Tork

21+3 tork ayarı

Auto-Lock
Anahtarsız
Metal Mandren
3X Üç Fonksiyonlu
Yüksek Güç
DARBELİ MATKAP
MATKAP - VIDALAMA

Akü kapasitesi	20V-2.0Ah-Li-ion
Hız - RPM	0-450/1500 d/dk
Darbe Oranı	0-6750-25500bpm
Tork gücü	45 Nm / 2 Vites
Tork Seviyesi	21+3
Şarj süresi	45 dakika
Mandren Aralığı	0,8-10mm



BATARYASIZ

20 Volt Darbeli Matkap
Batarya ve şarj ünitesi opsiyoneldir.
49\$
SGS5530B

Darbeli Matkap Seti

X-TECH
BRUSHLESS MOTOR
KÖMÜRSÜZ MOTOR
20V
MAX 2.0Ah

LITHIUM-ION TECHNOLOGY

2x
BATARYA
129\$
SGS5532

Koli 5 Adet

60
Nm Tork

21+3 tork ayarı

Auto-Lock
Anahtarsız
Metal
Mandren
3X Üç Fonksiyonlu
Yüksek Güç
DARBELİ MATKAP
MATKAP - VIDALAMA

Akü kapasitesi	20V-2.0Ah-Li-ion
Hız - RPM	0-600/1800 d/dk
Darbe Oranı	0-7500-28000bpm
Tork gücü	60 Nm / 2 Vites
Tork Seviyesi	21+3
Şarj süresi	45 dakika
Mandren Aralığı	0,8-10mm



BATARYASIZ

20 Volt Darbeli Matkap
Batarya ve şarj ünitesi opsiyoneldir.
59\$
SGS5532B

Darbeli Vidalama Seti

X-TECH
BRUSHLESS MOTOR
KÖMÜRSÜZ MOTOR
20V
MAX 2.0Ah

LITHIUM-ION TECHNOLOGY

2x
BATARYA
149\$
SGS5500

Koli 5 Adet

330
Nm Tork
0-3300 Bpm
DARBE GÜCÜ
Quick unlock
Hızlı Kilit Açma
Altıgen Mandren
1/4" 6,35mm
2X İki Kademeli
Darbe Gücü
DARBELİ
VIDALAMA

Akü kapasitesi	20V-2.0Ah-Li-ion
Hız - RPM	0-2000/2500 d/dk
Darbe Oranı	0-2600-3300 bpm
Tork gücü	330 Nm
Mandren Aralığı	1/4" 6,35mm
Şarj süresi	45 dakika



BATARYASIZ

20 Volt Darbeli Vidalama
Batarya ve şarj ünitesi opsiyoneldir.
79\$
SGS5500B

Darbeli Vidalama Seti

X-TECH

BRUSHLESS MOTOR
KÖMÜRSÜZ MOTOR20V
MAX 4.0Ah

LITHIUM-ION TECHNOLOGY

2x
BATARYA179\$
SGS5501

Koli 5 Adet

90 Dakika-Minute
Hızlı Şarj

Quick unlock

Hızlı Kilit Açma
Altıgen Mandren
1/4" 6,35mm330 Nm Tork
0-3300 Bpm
DARBE GÜCÜ2x İki Kademeli
Darbe Gücü
DARBELİ
VIDALAMA

Akü kapasitesi	20V-4.0Ah-Li-ion
Hız - RPM	0-2000/2500 d/dk
Darbe Oranı	0-2600-3300 bpm
Tork gücü	330 Nm
Mandren Aralığı	1/4" 6,35mm
Şarj süresi	90 dakika

20 Volt Darbeli Vidalama
Batarya ve şarj ünitesi
opsiyoneldir.79\$
SGS5500B

BATARYASIZ

Darbeli Somun Sıkma Seti

X-TECH

BRUSHLESS MOTOR
KÖMÜRSÜZ MOTOR20V
MAX 4.0Ah

LITHIUM-ION TECHNOLOGY

2x
BATARYA179\$
SGS5502

Koli 5 Adet

90 Dakika-Minute
Hızlı Şarj

1/2" square

Kare Başlı 1/2" Pimli Mil

1/4" square

Bitsi Uç Yuvası 1/4"

330 Nm Tork
0-3300 Bpm
DARBE GÜCÜ2x İki Kademeli
Darbe Gücü
DARBELİ
SOMUN SIKMA

Akü kapasitesi	20V-4.0Ah-Li-ion
Hız - RPM	0-2000/2500 d/dk
Darbe Oranı	0-2600-3300 bpm
Tork gücü	330 Nm
Kare Başlı	1/2" Pimli Mil
Şarj süresi	90 dakika

20 Volt Darbeli Somun Sıkma
Batarya ve şarj ünitesi
opsiyoneldir.79\$
SGS5502B

BATARYASIZ

Darbeli Somun Sıkma Seti

X-TECH

BRUSHLESS MOTOR
KÖMÜRSÜZ MOTOR20V
MAX 4.0Ah

LITHIUM-ION TECHNOLOGY

1x
BATARYA183\$
SGS5503

Koli 5 Adet

90 Dakika-Minute
Hızlı Şarj

Lokma Ucu

22mm Lokma Ucu 1 Adet

1/2" square

Kare Başlı 1/2" Pimli Mil

650 Nm Tork
0-4000 Bpm
DARBE GÜCÜ3x Üç Kademeli
Darbe Gücü
DARBELİ
SOMUN SIKMA

Akü kapasitesi	20V-4.0Ah-Li-ion
Hız - RPM	0-1300/1900/2200 d/dk
Darbe Oranı	0-2600-3300-4000 bpm
Tork gücü	650 Nm
Kare Başlı	1/2" Pimli Mil
Şarj süresi	90 dakika

20 Volt Darbeli Somun Sıkma
Batarya ve şarj ünitesi
opsiyoneldir.125\$
SGS5503B

BATARYASIZ

Kırıcı-Delici Matkap Seti

X-TECH

BRUSHLESS MOTOR
KÖMÜRSÜZ MOTOR20V
MAX 4.0Ah

LITHIUM-ION TECHNOLOGY

2x
BATARYA239\$
SGS5520

Koli 4 Adet

90 Dakika-Minute
Hızlı Şarj1.8 Joules
0-4500 Bpm
DARBE GÜCÜ

SDS Plus

2x İki Fonksiyonlu
Yüksek Güç
KIRICI - DELİCİ MATKAP
ELEKTRO PNÖMATİK

Akü kapasitesi	20V-4.0Ah-Li-ion
Hız - RPM	0-1400 d/dk
Darbe Oranı	0-4500 bpm
Darbe Gücü	1.8 Joules
Aşap-Metal-Beton	30 - 13 - 22 mm
Şarj süresi	90 dakika

20 Volt Kırıcı-Delici Matkap
Batarya ve şarj ünitesi
opsiyoneldir.139\$
SGS5520B

BATARYASIZ

Kırıcı-Delici Matkap Seti

BRUSHLESS MOTOR

KÖMÜRSÜZ
MOTOR

X-TECH

20V
MAX 4.0Ah

LITHIUM-ION TECHNOLOGY

2x
BATARYA249\$
SGS5521

Koli 2 Adet

90 Dakika-Minute
Hızlı Şarj2.8 Joules
0-5300 Bpm
DARBE GÜCÜ

SDS Plus

3x Üç Fonksiyonlu
Yüksek Güç
KIRICI - DELİCİ MATKAP
ELEKTRO PNÖMATİK

Akü kapasitesi	20V-4.0Ah-Li-ion
Hız - RPM	0-1200 d/dk
Darbe Oranı	0-5300 bpm
Darbe Gücü	2.8 Joules
Aşap-Metal-Beton	30 - 13 - 26 mm
Şarj süresi	90 dakika

20 Volt Kırıcı-Delici Matkap
Batarya ve şarj ünitesi
opsiyoneldir.149\$
SGS5521B

BATARYASIZ

Avuç Taşlama Makine Seti

X-TECH
BRUSHLESS MOTOR
KÖMÜRSÜZ MOTOR

20V
MAX 4.0Ah

LITHIUM-ION TECHNOLOGY

2x
BATARYA



179\$
SGS5510

Koli 4 Adet

115
MM

M-14
Bağlantı



90 **2.5A**
Dakika-Minute
Hızlı Şarj



2X MAXIMUM
RUNTIME



Akü kapasitesi	20V-4.0Ah-Li-ion
Hız - RPM	0-4500/7000/8500 d/dk
Disk Ölçü	Ø115mm
Bağlantı Ucu	M-14
Şarj süresi	90 dakika



20 Volt Avuç Taşlama
Batarya ve şarj ünitesi
opsiyoneldir.

79\$
SGS5510B

BATARYASIZ

Mermer & Granit Kesme Makinesi Seti

BRUSHLESS MOTOR
KÖMÜRSÜZ MOTOR

20V
MAX 4.0Ah

LITHIUM-ION TECHNOLOGY

1x
BATARYA



145\$
SGS5540

Koli 8 Adet

125
MM

90 **2.5A**
Dakika-Minute
Hızlı Şarj



X-TECH

1 Yıl Garanti
2 Yıl Garanti



2X MAXIMUM
RUNTIME

Akü kapasitesi	20V-4.0Ah-Li-ion
Hız - RPM	6500 d/dk
Disk Ölçü	Ø125mm
Kesme Derinlik	45°/90° 20-38mm
Şarj süresi	90 dakika



20 Volt Mermer & Granit
Kesme Makinesi

Batarya ve şarj ünitesi
opsiyoneldir.

89\$
SGS5540B

BATARYASIZ

Sunta Kesme Makine Seti

BRUSHLESS MOTOR
KÖMÜRSÜZ MOTOR

20V
MAX 4.0Ah

LITHIUM-ION TECHNOLOGY

1x
BATARYA



165\$
SGS5541

Koli 6 Adet

165
MM

90 **2.5A**
Dakika-Minute
Hızlı Şarj



X-TECH

1 Yıl Garanti
2 Yıl Garanti



2X MAXIMUM
RUNTIME

Akü kapasitesi	20V-4.0Ah-Li-ion
Hız - RPM	4800 d/dk
Disk Ölçü	Ø165 mm
Kesme Derinlik	45°/90° 38-56mm
Şarj süresi	90 dakika



20 Volt Sunta
Kesme Makinesi

Batarya ve şarj ünitesi
opsiyoneldir.

109\$
SGS5541B

BATARYASIZ

Budama Makası Seti

X-TECH
BRUSHLESS MOTOR
KÖMÜRSÜZ MOTOR

20V
MAX 2.0Ah

LITHIUM-ION TECHNOLOGY

2x
BATARYA



189\$
SGS5555

Koli 5 Adet

45 **2.5A**
Dakika-Minute
Hızlı Şarj



2X MAXIMUM
RUNTIME

SK-5

Steel Blade
Durable Sharp Edge

Akü kapasitesi	20V-2.0Ah-Li-ion
Ağaç Kesme	Ø25-40mm
Şarj süresi	45 dakika



20 Volt Budama Makası
Batarya ve şarj ünitesi
opsiyoneldir.

119\$
SGS5556B

BATARYASIZ

Ağaç Kesme Testeresi Seti

BRUSHLESS MOTOR **X-TECH**
KÖMÜRSÜZ MOTOR

20V
MAX 4.0Ah

LITHIUM-ION TECHNOLOGY

1x
BATARYA



179\$
SGS5320

Koli 4 Adet

90 **2.5A**
Dakika-Minute
Hızlı Şarj



2X MAXIMUM
RUNTIME

Akü kapasitesi	20V-4.0Ah-Li-ion
Pompa Yağı Akışı	Otomatik Yağlama
Yağ Kapasitesi	60 ml
Pala Uzunluğu	10" (25cm)
Zincir Hızı	8 m/s
Motor	Kömürsüz Motor
Şarj süresi	90 dakika



20 Volt Ağaç Kesme Testeresi
Batarya ve şarj ünitesi
opsiyoneldir.

119\$
SGS5320B

BATARYASIZ

Tırpan Seti

X-TECH
BRUSHLESS MOTOR
KÖMÜRSÜZ MOTOR

20V
MAX 4.0Ah
LITHIUM-ION TECHNOLOGY

209\$
SGS5335
Koli 4 Adet

2X MAXIMUM
RUNTIME

1 YIL GARANTİ
KÖMÜRSÜZ

2 YIL GARANTİ
LİTYUM İYON

2 Kademeli
Hız Ayarı
LOW - HIGH
Akü Güç
Göstergesi

Akü kapasitesi 20V-4.0Ah-Li-ion
Hız - RPM 0-5000/7000 d/dk
Motor Kömürsüz Motor
Şarj süresi 90 dakika

1x
BATARYA



90 **2.5A**
Dakika-Minute
Hızlı Şarj

Trimmer Head
Universal Automatic
Misina Başlığı

Saw Blade
Yüksek Kalite
3T Testere Bıçağı



20 Volt Tırpan
Batarya ve şarj ünitesi
opsiyoneldir.

154\$
SGS5335B

BATARYASIZ

Zimba ve Çivi Tabancası Seti

20V
MAX 4.0Ah
LITHIUM-ION TECHNOLOGY

229\$
SGS5165
Koli 4 Adet

1x
BATARYA



90 **2.5A**
Dakika-Minute
Hızlı Şarj

1 YIL GARANTİ
KÖMÜRSÜZ



18GA
40mm Zimba Boyutu
(90 Serisi Zimba Teli)
50mm Çivi Boyutu

ÇİVİ ÖLÇÜSÜ
Kalınlık Baş Kalınlık Uzunluk
1.2-1mm 2.1mm 20-50mm

ZIMBA ÖLÇÜSÜ
Kalınlık Çene Kalınlık Bacak Uzunluk
1.2-1mm 6mm 90-20mm / 90-40mm
(90 Serisi Zimba Teli)



20 Volt Zimba ve Çivi
Tabancası
Batarya ve şarj ünitesi
opsiyoneldir.

174\$
SGS5165B

BATARYASIZ

Basıncılı Yıkama Makine Seti

20V
MAX 2.0Ah
LITHIUM-ION TECHNOLOGY

119\$
SGS5410
Koli 5 Adet

1x
BATARYA



45 **2.5A**
Dakika-Minute
Hızlı Şarj

1 YIL GARANTİ
KÖMÜRSÜZ

NEW
system
30 bar **50%** Su
435 PSI Tasarrufu

1 YIL GARANTİ
KÖMÜRSÜZ

2 YIL GARANTİ
LİTYUM İYON



Suyu Kaynağından Çeker
2 Metre Emiş Yüksekliği

240 Lt/H
Su Debisi

Akü Güç
Göstergesi

1x
BATARYA



45 **2.5A**
Dakika-Minute
Hızlı Şarj

1 YIL GARANTİ
KÖMÜRSÜZ

0° 15° 25° 40° 60°
6'sı 1 Arada Püskürtme Nozulu

Köpüklü
Yıkama için
Deterjan Tankı

6 Metre
PVC
Hortum

Auto-Stop
Tetik
Bırakıldığında
pompa kapanır.



20 Volt Basıncılı
Yıkama Makinesi
Batarya ve şarj ünitesi
opsiyoneldir.

79\$
SGS5410B

BATARYASIZ

20V MAX 1.5Ah
LI-ION TECHNOLOGY
SGS Plus 1.5 Ah
Akülü Aletlerle Uyumludur.
SGS5248-SGS5249

Li



Batarya Güç Göstergesi

19\$
SGS5246



HI-TECH

20V MAX 2.0Ah
LI-ION TECHNOLOGY
SGS Plus 2.0 Ah
Akülü Aletlerle Uyumludur.

Li



Batarya Güç Göstergesi

29\$
SGS5497



X-TECH

2.5A Hızlı Şarj Ünitesi

45 dakika 2.0Ah
90 dakika 4.0Ah

14\$
SGS5499



20V MAX 4.0Ah
LI-ION TECHNOLOGY
SGS Plus 4.0 Ah
Akülü Aletlerle Uyumludur.

Li



Batarya Güç Göstergesi

44\$
SGS5498



X-TECH

Vidalama Seti



HI-TECH



2X MAXIMUM RUNTIME
İki Devirli Yüksek Güç

12V
MAX 1.5Ah



BATARYA

13\$
SGS5137

12V
MAX 1.5Ah

LITHIUM-ION TECHNOLOGY

2x
BATARYA



52\$
SGS5131

Koli 10 Adet

60 1.5A
Dakika-Minute
Hızlı Şarj

26 Nm Tork

20+1 tork ayarı

Auto-Lock

Anahtarsız Mandren

1 YIL GARANTİ
KOSULSUZ

2 YIL GARANTİ
Diğer Ürünler İçin



Akü kapasitesi	12V-1.5Ah-Li-ion
Hız - RPM	0-350/1300 d/dk
Tork gücü	26 Nm / 2 Vites
Tork Seviyesi	20+1
Şarj süresi	60 dakika
Mandren Aralığı	0,8-10mm

Şarjlı Led Fener



3-4 Saat
Pil Ömrü

Güçlü
Mıknatıs

Aski & Katlanır
Ayak

Darbeye
Dayanıklı

400 LUMENS
HIGH POWER

4X

4 Kademeli
Işık Modu

3.7V
MAX 1.5Ah

LITHIUM-ION TECHNOLOGY

USB
CHARGER

MADE IN
TÜRKİYE



Darbesiz Matkap

HI-TECH



2X MAXIMUM PERFORMANCE

500 Watt

35\$
SGS5140

Koli 10 Adet

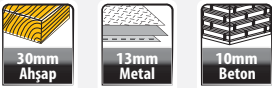

Nominal Güç	500 Watt
Hız - RPM	0-3000 d/dk
Ahşap	30 mm
Metal	13 mm
Beton	10 mm
Mandren Aralığı	2-13mm

Darbeli Matkap

HI-TECH

İki Fonksiyonlu Yüksek Güç



2X MAXIMUM PERFORMANCE

600 Watt

39\$
SGS5141

Koli 6 Adet

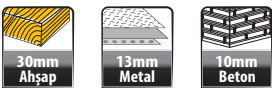

Nominal Güç	600 Watt
Hız - RPM	0-2800 d/dk
Darbe Oranı	0-44800 Bmp
Beton	10 mm
Ahşap - Metal	30 - 13 mm
Mandren Aralığı	2-13mm

Darbeli Matkap

HI-TECH

İki Fonksiyonlu Yüksek Güç



2X MAXIMUM PERFORMANCE

750 Watt

45\$
SGS5142

Koli 6 Adet



Nominal Güç	750 Watt
Hız - RPM	0-2800 d/dk
Darbe Oranı	0-44800 Bmp
Beton	10 mm
Ahşap - Metal	35 - 13 mm
Mandren Aralığı	2-13mm

**Kırıcı-Delici
Matkap****HI-TECH**Üç Fonksiyonlu Yüksek Güç
ELEKTROPNÖMATİK**800 Watt****85\$****SGS5179**

Koli 5 Adet

5 Parça
Uç Seti**3X** MAXIMUM
PERFORMANCE

Nominal Güç	800 Watt
Hız - RPM	0-1200 d/dk
Darbe Oranı	0-5300 Bpm
Darbe Gücü	3.0 Joules
Beton	26 mm
Ahşap - Metal	26 - 13 mm

**Kırıcı-Delici
Matkap****HI-TECH**Üç Fonksiyonlu Yüksek Güç
ELEKTROPNÖMATİK**800 Watt****90\$****SGS5180**

Koli 4 Adet

5 Parça
Uç Seti**3X** MAXIMUM
PERFORMANCE

Nominal Güç	800 Watt
Hız - RPM	0-1300 d/dk
Darbe Oranı	0-5500 Bpm
Darbe Gücü	2.8 Joules
Beton	26 mm
Ahşap - Metal	26 - 13 mm

**Kırıcı-Delici
Matkap****HI-TECH**Üç Fonksiyonlu Yüksek Güç
ELEKTROPNÖMATİK**1500 Watt****119\$****SGS5183**

Koli 2 Adet

**3X** MAXIMUM
PERFORMANCE

Nominal Güç	1500 Watt
Hız - RPM	0-850 d/dk
Darbe Oranı	0-4100 Bpm
Darbe Gücü	5.0 Joules
Beton	32 mm
Ahşap - Metal	30 - 13 mm

**Kırıcı-Delici
Matkap****HI-TECH**Üç Fonksiyonlu Yüksek Güç
ELEKTROPNÖMATİK**1200 Watt****139\$****SGS5178**

Koli 2 Adet

**3X** MAXIMUM
PERFORMANCE

Nominal Güç	1200 Watt
Hız - RPM	260-1050 d/dk
Darbe Oranı	1380-5570 Bpm
Darbe Gücü	7.0 Joules
Beton	38 mm
Ahşap - Metal	30 - 13 mm

**Kırıcı-Delici
Matkap****HI-TECH**Üç Fonksiyonlu Yüksek Güç
ELEKTROPNÖMATİK**1200 Watt****159\$****SGS5182**

Koli 2 Adet

**3X** MAXIMUM
PERFORMANCE

Nominal Güç	1200 Watt
Hız - RPM	260-1050 d/dk
Darbe Oranı	1380-5570 Bpm
Darbe Gücü	7.0 Joules
Beton	40 mm
Ahşap - Metal	30 - 13 mm

Avuç Taşlama Makinesi

HI-TECH

750 Watt

37\$

SGS5109

Koli 10 Adet

115
MM2X
MAXIMUM
RUNTIME

Nominal Güç	750 Watt
Hız - RPM	0-11000 d/dk
Disk Ölçü	115 mm
Bağlantı Uç	M-14

Avuç Taşlama Makinesi

HI-TECH

750 Watt

39\$

SGS5111

Koli 10 Adet

115
MM

Kademeli Hız

2X
MAXIMUM
RUNTIME

Nominal Güç	750 Watt
Hız - RPM	3000-11000 d/dk
Disk Ölçü	115 mm
Bağlantı Uç	M-14

Avuç Taşlama Makinesi

HI-TECH

850 Watt

39\$

SGS5108

Koli 10 Adet

115
MM2X
MAXIMUM
RUNTIME

Nominal Güç	850 Watt
Hız - RPM	0-11000 d/dk
Disk Ölçü	115mm
Bağlantı Uç	M-14

Avuç Taşlama Makinesi

HI-TECH

1010 Watt

49\$

SGS5112

Koli 10 Adet

125
MM2X
MAXIMUM
RUNTIME

Nominal Güç	1010 Watt
Hız - RPM	0-11000 d/dk
Disk Ölçü	125 mm
Bağlantı Uç	M-14

Taşlama Makinesi

HI-TECH

2500 Watt

120\$

SGS5116

Koli 2 Adet

180
MM360°
Dönen Tutma Kolu2X
MAXIMUM
RUNTIME

Nominal Güç	2500 Watt
Hız - RPM	6800 d/dk
Disk Ölçü	180 mm
Bağlantı Uç	M-14

Taşlama
Makinesi

HI-TECH

2500Watt

123\$

SGS5117

Koli 2 Adet

230
MM360°
Dönen
Tutma Kolu1 YIL
GARANTİ
KOŞULSUZ2 YIL
GARANTİ
Uzun Hatalıma Karşı2X
MAXIMUM
RUNTIME

Nominal Güç	2500 Watt
Hız - RPM	6300 d/dk
Disk Ölçü	230 mm
Bağlantı Uç	M-14

Polisaj
Makinesi

HI-TECH

1400Watt

105\$

SGS5115

Koli 4 Adet

180
MM

Cırtlı Zımpara + İpli Peluş + P120 Kum Zımpara Tabanı

1 YIL
GARANTİ
KOŞULSUZ2 YIL
GARANTİ
Uzun Hatalıma Karşı2X
MAXIMUM
RUNTIME

Nominal Güç	1400 Watt
Hız - RPM	900-4000 d/dk
Polisaj Disk	Ø180 mm
Bağlantı Uç	M-14

Dekupaj
Testere

HI-TECH

500Watt

33\$

SGS5192

Koli 10 Adet

Kademeli
Hız
Anahtarsız
Hızlı Bıçak
Montajı

45° Açılı Kesim

Toz Emme Kanalı

Kılavuz Cetvel

T144D
1Adet Ahşap Testere2X
MAXIMUM
RUNTIME1 YIL
GARANTİ
KOŞULSUZ2 YIL
GARANTİ
Uzun Hatalıma Karşı

Nominal Güç	500 Watt
Hız - Rpm.	0-3000 d/dk
Ahşap - Metal	55-6 mm
Alüminyum	12 mm

Dekupaj
Testere

HI-TECH

600Watt

60\$

SGS5190

Koli 5 Adet

Kademeli
Hız
Anahtarsız
Hızlı Bıçak
Montajı

45° Açılı Kesim

Toz Emme Kanalı

Kılavuz Cetvel

T144D
2Adet Ahşap Testere

3 Kademeli Kesim

3X
Kademeli
Pandül1 YIL
GARANTİ
KOŞULSUZ2 YIL
GARANTİ
Uzun Hatalıma Karşı

Nominal Güç	600 Watt
Hız - Rpm.	800-2800 d/dk
Ahşap - Metal	65-6 mm
Alüminyum	12 mm

Dekupaj
Testere

HI-TECH

900Watt

70\$

SGS5191

Koli 5 Adet

Kademeli
Hız
Anahtarsız
Hızlı Bıçak
Montajı

45° Açılı Kesim

Alüminyum Taban

Toz Emme Kanalı

Kılavuz Cetvel

T144D
2Adet Ahşap Testere

3 Kademeli Pandül

3X
Kademeli
Pandül1 YIL
GARANTİ
KOŞULSUZ2 YIL
GARANTİ
Uzun Hatalıma Karşı

Nominal Güç	900 Watt
Hız - Rpm.	800-2800 d/dk
Ahşap - Metal	65-6 mm
Alüminyum	12 mm

Sunta Kesme Makinesi

HI-TECH
1500 Watt
74\$
SGS5185

Koli 6 Adet

185 MM

Ø185mm Ø20mm

2X
 MAXIMUM
 RUNTIME

Nominal Güç	1500 Watt
Hız - RPM	5400 d/dk
Kesim Disk	Ø185 mm
Kesme Derinlik	45°- 44mm
Kesme Derinlik	90°- 65mm

Tilki Kuyruğu Testere

HI-TECH
1200 Watt
118\$
SGS5270

Koli 4 Adet

 240mm
 1Adet Ahşap Testere
 150mm
 1Adet Metal Testere

Led Işık



Kademeli Hız



Anahtar Kilidi



1 YIL GARANTİ KOŞULSUZ



2 YIL GARANTİ Üstün Kaliteye Kaygı

3X
 Kademeli
 Pandül

Nominal Güç	1200 Watt
Hız - Rpm.	1000-2800d/dk
Ahşap	210 mm
Metal	10 mm
Alüminyum	20 mm



Anahtarsız Hızlı Bıçak Montajı

Karıştırıcı Mixer

Boya Ve Harç Karıştırıcı

HI-TECH
1600 Watt
84\$
SGS5099

Koli 4 Adet



Otomatik Stop

2X
 MAXIMUM
 RUNTIME

Nominal Güç	1600 Watt
Hız - RPM	260-900 d/dk
Bağlantı Ucu	M-14 / 120mm

Karıştırıcı Mixer

İki Devirli Boya Ve Harç Karıştırıcı

HI-TECH
1800 Watt
114\$
SGS5100

Koli 2 Adet



Otomatik Stop

2X
 MAXIMUM
 RUNTIME

Nominal Güç	1800 Watt
1. Hız - RPM	180-400 d/dk
2. Hız - RPM	300-700 d/dk
Bağlantı Ucu	M-14 / 120mm

Eksantrik Zımpara Makinesi

HI-TECH
350 Watt
234\$
SGS5253

Koli 4 Adet

150 MM

5.0E
 Random
 Orbital

4 Adet Cırtlı Zımpara

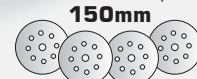
2X

BRUSHLESS MOTOR
 KÖMÜRSÜZ MOTOR

Nominal Güç	350 Watt
Hız - RPM	4000-10000 Rpm
Zımpara Ölçüsü	150mm
Salınım	5mm

Hobi Gravür Seti 211 Parça

HI-TECH

130 Watt

50\$

SGS5260

Koli 10 Adet



2X
MAXIMUM
RUNTIME

Nominal Güç
130 Watt

Hız - RPM
8000/33000 d/dk

Disk Çapı
Ø3,2 mm

Sıcak Hava Tabancası

HI-TECH

2000 Watt

29\$

SGS5215

Koli 10 Adet



2X
MAXIMUM
RUNTIME

Maksimum Güç
2000 Watt

Hava Akımı
I : 300L - II : 500L

Sıcaklık
I : 350° - II : 600°



350°C

1 : 300 L / MIN

600°C

2 : 500 L / MIN



Hava Körüğü

HI-TECH

650 Watt

30\$

SGS5221

Koli 8 Adet



2X
MAXIMUM
RUNTIME

Nominal Güç
650 Watt

Üfleme Hızı
0-3.2m³/dak.

Boştaki Devir Hızı
0-14000/min.

Koyun Kırkma Makinesi

HI-TECH

500 Watt

119\$

SGS5197

Koli 5 Adet



Filtreli Ekstra
Hava Kanalı



Hızlı ve Kolay
Bıçak Ağız Ayarı

6 Kademeli
Hız Ayarı

Fast Cut

80mm Ekstra Güçlü
Kesici Bıçak

2X
MAXIMUM
RUNTIME

Nominal Güç 500 Watt

Hız - RPM 0-2400 d/dk

Bıçak Genişlik 80 mm

Hız Ayarı 6 Seviye



Koyun Kırkma Makinesi Yedek Bıçak

5\$

SGS5198

Koli 10 Adet

STRONG
CUTTER BLADE



Koyun Kırkma Makinesi Yedek Bıçak

11.50\$

SGS5199

Koli 5 Adet

STRONG
CUTTER BLADE



Havasız Boya Püskürtme Makinesi

HI-TECH

1010 Watt 299\$

SGS5280

Koli 1 Adet

1 YIL GARANTİ
KOŞULSUZ

2 YIL GARANTİ
DİĞER HİTECH ALETLER İÇİN

NEW system



207 bar 3000PSI



515 Nozzle

Akış Hızı: 1,5 L / dak.

Püskürtme Geniřliđi: 15 cm - 20 cm.



Basınç Göstergesi



10Metre

Basınca Dayanıklı Hortum

Basıncılı Yıkama Makinesi

HI-TECH

1800 Watt 160\$

SGS5400

Koli 1 Adet

1 YIL GARANTİ
KOŞULSUZ

2 YIL GARANTİ
DİĞER HİTECH ALETLER İÇİN

NEW system



150 bar 2175PSI



Ayarlanabilir Püskürtme Bařlıđı



5 Metre Yüksek Basınca Dayanıklı Çelik Hortum



Auto-Stop

Emniyetli Otomatik Durdurma Sistemi

Enerji tasarrufu ve daha uzun pompa ömrü için tetik etkinleştirilmediğinde pompayı otomatik olarak kapatır.



Basıncılı Yıkama Makinesi

HI-TECH

2500 Watt 340\$

SGS5401

Koli 1 Adet

1 YIL GARANTİ
KOŞULSUZ

2 YIL GARANTİ
DİĞER HİTECH ALETLER İÇİN

NEW system



170 bar 2465PSI

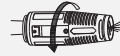

Ayarlanabilir Püskürtme Bařlıđı



5 Metre Yüksek Basınca Dayanıklı Çelik Hortum



Auto-Stop

Emniyetli Otomatik Durdurma Sistemi

Enerji tasarrufu ve daha uzun pompa ömrü için tetik etkinleştirilmediğinde pompayı otomatik olarak kapatır.



Kanal Açma Makinesi

HI-TECH

3000 Watt 240\$

SGS5300

Koli 1 Adet

1 YIL GARANTİ
KOŞULSUZ

2 YIL GARANTİ
DİĞER HİTECH ALETLER İÇİN



5 Parça Bıçak Seti



Teşik Kilit Anahtarı



36mm Derinlik



BETON



MERMER



SERAMİK

180° Dönen Tutma Kolu



Nominal Güç 3000 Watt

Maksimum Güç 4800 Watt

Hız - RPM 6500 d/dk

Kesme Kapasitesi 38-36mm

Kesim Disk 133mm



133mm Elmas Testere Bıçacı
1 Adet

11\$
SGS5301

Alçı Zımpara Makinesi

HI-TECH

750 Watt 240\$

SGS5200

Koli 1 Adet

1 YIL GARANTİ
KOŞULSUZ

2 YIL GARANTİ
DİĞER HİTECH ALETLER İÇİN



Elektrikli süpürge gerektirmeyen toz emme sistemi



Kademeli Hız



LED



Katlanabilir Kol

6 ADET Dört Zımpara 225mm



Nominal Güç 750Watt

Hız - RPM 1000-1850 d/dk

Kesim Disk Ø225 mm

Tutamak Uzunluđu 130-180 mm



Toz Vakum Sistemi

Motorlu Tırpan

HI-TECH

2X İki Zamanlı Motor Yüksek Güç

52CC 1.6kw

135\$

SGS5361

Koli 1 Adet



Saw Blade

40T / 1 Adet Dairesel Testere

Motor Hacmi 52cc

Motor Gücü 1.6 kw

Devir Hızı 8500rpm

Yakıt Kapasitesi 1250 ml

Motorlu Tırpan Sırt Tipi

HI-TECH

2X İki Zamanlı Motor Yüksek Güç

52CC 1.6kw

159\$

SGS5362

Koli 1 Adet



Saw Blade

40T / 1 Adet Dairesel Testere

Motor Hacmi 52cc

Motor Gücü 1.6 kw

Devir Hızı 8500rpm

Yakıt Kapasitesi 1250 ml

Ağaç Kesme Motoru

2X İki Zamanlı Motor Yüksek Güç

HI-TECH

45cm Pala Boyu

52CC 2.2kw

125\$

SGS5354

Koli 4 Adet



Motor Hacmi 52cc

Motor Gücü 2.2 Kw

Silindir Çapı Ø 45mm

Pala Uzunluğu 45 cm

Yakıt Kapasitesi 550 ml

Yağ Kapasitesi 260 ml

İnvertör Kaynak Makinesi

HI-TECH

200A

350\$

SGS5162

Koli 1 Adet



Islak Alanlarda Güvenli Çalışma



IGBT TECHNOLOGY

Şebekeden Çekilen Güç 8.2 kVA

Şebekeden Çekilen Akım 38 A

Kaynak Akım Aralığı 40~200 ADC

Elektrod Çapı 1,60 - 4,00

Ağırlık 6,5 Kg



35 Parça Ürün Standı

Kod	Açıklama	Adet
SGS5050	400 Lümen Şarjlı Led Fener	2
SGS5131	12 Volt Akülü Vidalama Seti	2
SGS5248	20 Volt Darbeli Matkap Seti	2
SGS5249	20 Volt Matkap Seti	2
SGS5510	20 Volt Avuç Taşlama Makine Seti	1
SGS5530	20 Volt Darbeli Matkap Seti	1
SGS5541	20 Volt Sunta Kesme Makine Seti	1
SGS5140	500 Watt Darbesiz Matkap	2

Kod	Açıklama	Adet
SGS5141	600 Watt Darbeli Matkap	2
SGS5142	750 Watt Darbeli Matkap	2
SGS5179	800 Watt Kırıcı/Delici Matkap	2
SGS5109	750 Watt Avuç Taşlama 115mm	2
SGS5111	750 Watt Avuç Taşlama 115mm	1
SGS5108	850 Watt Avuç Taşlama 115mm	1
SGS5112	1010 Watt Avuç Taşlama 125mm	1
SGS5115	1400 Watt Polisaj Makinesi	1

Kod	Açıklama	Adet
SGS5192	500 Watt Dekupaj Makinesi	2
SGS5191	900 Watt Dekupaj Makinesi	1
SGS5185	1500 Watt Sunta Kesme Makinesi	1
SGS5260	130 Watt Hobi Gravür Seti	2
SGS5215	2000 Watt Sıcak Hava Tabancası	2
SGS5099	1600 Watt Karıştırıcı Mixer	1

2063\$

SGS5129

34 parça elektrikli el aletleri ile metal stand bedelsiz olarak verilmektedir.



Temiz Su Dalgıç Pompası

NEW
system

500 Watt

59\$

SGS5370

Koli 4 Adet

1 YIL GARANTİ
KOSULSUZ

2 YIL GARANTİ
Uzun Yaşamaya Kafi

25-32mm
Hortum Bağlantısı

10 Metre
Kablo Uzunluk



9 METRE
Su Basma Yüksekliği



12.000 Lt/H
Su Akış Kapasitesi

SUYU KAYNAĞINDAN ÇEKER



Max Su Akış Kapasitesi	12.000 Lt/H
Max Kaldırma Yüksekliği	9 Metre
Max Daldırma Derinliği	7 Metre
Katı Cisimlerin Emilmesi	Ø 5mm
Hortum Bağlantısı	25-32mm 1" & 1-1/2"
Güç Kablosu	10 Metre H05RN-F/3G 0.75mm 2x10m

Temiz-Kirli Su Dalgıç Pompası

NEW
system

900 Watt

79\$

SGS5371

Koli 4 Adet

1 YIL GARANTİ
KOSULSUZ

2 YIL GARANTİ
Uzun Yaşamaya Kafi

25-32mm
Hortum Bağlantısı

10 Metre
Kablo Uzunluk



9 METRE
Su Basma Yüksekliği



13.000 Lt/H
Su Akış Kapasitesi

SUYU KAYNAĞINDAN ÇEKER



Max Su Akış Kapasitesi	13.000 Lt/H
Max Kaldırma Yüksekliği	9 Metre
Max Daldırma Derinliği	7 Metre
Katı Cisimlerin Emilmesi	Ø 1-8-35mm
Hortum Bağlantısı	25-32mm 1" & 1-1/2"
Güç Kablosu	10 Metre H05RN-F/3G 0.75mm 2x10m

Temiz Su Dalgıç Pompası

NEW
system

900 Watt

129\$

SGS5372

Koli 1 Adet

1 YIL GARANTİ
KOSULSUZ

2 YIL GARANTİ
Uzun Yaşamaya Kafi

25-32mm
Hortum Bağlantısı

10 Metre
Kablo Uzunluk



30 METRE
Su Basma Yüksekliği



5.000 Lt/H
Su Akış Kapasitesi

SUYU KAYNAĞINDAN ÇEKER



Max Su Akış Kapasitesi	5.000 Lt/H
Max Kaldırma Yüksekliği	30 Metre
Max Daldırma Derinliği	7 Metre
Katı Cisimlerin Emilmesi	Ø 2mm
Hortum Bağlantısı	25-32mm 1" & 1-1/2"
Güç Kablosu	10 Metre H05RN-F/3G 1.00mm 2x10m

Kirli Su Dalgıç Pompası

NEW
system

1100 Watt

99\$

SGS5373

Koli 4 Adet

1 YIL GARANTİ
KOSULSUZ

2 YIL GARANTİ
Uzun Yaşamaya Kafi

25-32mm
Hortum Bağlantısı

10 Metre
Kablo Uzunluk



INOX

10 METRE
Su Basma Yüksekliği



15.000 Lt/H
Su Akış Kapasitesi

SUYU KAYNAĞINDAN ÇEKER



Max Su Akış Kapasitesi	15.000 Lt/H
Max Kaldırma Yüksekliği	10 Metre
Max Daldırma Derinliği	7 Metre
Katı Cisimlerin Emilmesi	Ø 35mm
Hortum Bağlantısı	25-32mm 1" & 1-1/2"
Güç Kablosu	10 Metre H05RN-F/3G 0.75mm 2x10m

Bahçe Su Pompası

NEW
system

1200 Watt

129\$

SGS5374

Koli 1 Adet

1 YIL GARANTİ
KOSULSUZ

2 YIL GARANTİ
Uzun Yaşamaya Kafi

25mm
Hortum Bağlantısı

1.2 Metre
Kablo Uzunluk



On-Off
Anahtar



50 METRE
Su Basma Yüksekliği



3.800 Lt/H
Su Akış Kapasitesi

SUYU KAYNAĞINDAN ÇEKER



Max Su Akış Kapasitesi	3.800 Lt/H
Max Kaldırma Yüksekliği	50 Metre
Max Daldırma Derinliği	8 Metre
Hortum Bağlantısı	25mm / 1"
Güç Kablosu	1.2 Metre H05RN-F/3G 1mm 2x1.2m IPX4



20V MAX
Li-ion X-TECH



ONE BATTERY MAX POWER
TEK BATARYA MAKSİMUM GÜÇ



SGS®

DEV120

1200mm

SERAMİK & GRANİT
KESME MAKİNASI



22MM
TITANIUM
COATING
TUNGSTEN
CARBIDE

MAXIMUMSTRONG
STRONG AND SOLID METAL BODY



SGS[®]

Professional Hand Tools

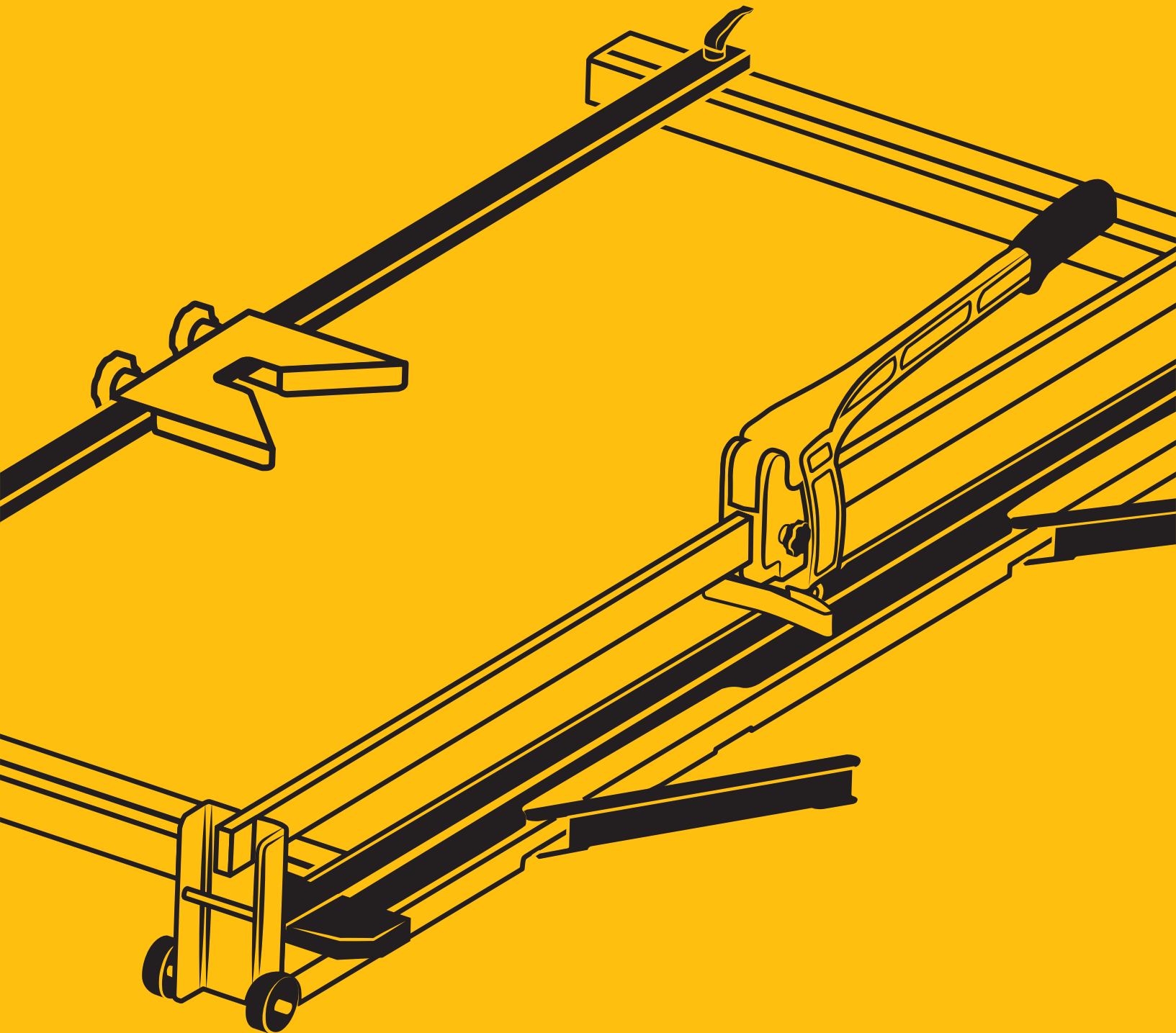

PRO Series MAXIMUMSTRONG
STRONG METAL BODY

Seramik & Granit Kesme Makinası

Metal Gövde Pro 60-90Uzun Ömürlü Değiştirilebilir
Kesme ElmasıAyarlanabilir
Alüminyum Cetveli
Gönye Sistemi**STRONG**
DIAMOND
CUTTER BLADEMADE IN
TÜRKİYEEXTRA
STRONG2YIL
GARANTİ
ÜRETİM
MÜHÜRÜ**600-900mm**Özel Malzemeden Üretilmiş Kırılma ve
Aşınmaya Dayanıklı Kesici Kol
En İyi Kesimler İçin Tekli Lama Sistemi

KODU	AÇIKLAMA	KOLİ	FIYATI
SGS102	Pro 60/600mm	4	1.600₺
SGS103	Pro 90/900mm	1	2.100₺

MAC Series MAXIMUMSTRONG
STRONG METAL BODY

Seramik & Granit Kesme Makinası

Metal Gövde Mac 50 - 60Uzun Ömürlü Değiştirilebilir
Kesme ElmasıPlastik Cetveli
Gönye**STRONG**
DIAMOND
CUTTER BLADEMADE IN
TÜRKİYEEXTRA
STRONG2YIL
GARANTİ
ÜRETİM
MÜHÜRÜ**500-600mm**Özel Malzemeden Üretilmiş Kırılma ve
Aşınmaya Dayanıklı Kesici Kol
En İyi Kesimler İçin Tekli Lama Sistemi

KODU	AÇIKLAMA	KOLİ	FIYATI
SGS122	Mac 50/500mm	4	1.100₺
SGS123	Mac 60/600mm	4	1.300₺

X-PLUS60 MAXIMUMSTRONG
STRONG AND LIGHTWEIGHT ALUMINUM BODY

Seramik & Granit Kesme Makinası

Alüminyum GövdeGüçlü ve Hassas
Rulmanlı Çift Mil
Kesim Sistemi10mm
Kalem
Elmas Uç**STRONG**
DIAMOND
CUTTER BLADEEXTRA
STRONG2YIL
GARANTİ
ÜRETİM
MÜHÜRÜ

45°

**Plastik Taşıma Çantası**Kırılma ve Aşınmaya Dayanıklı Kesici Kol
Ayarlanabilir Alüminyum Cetveli Gönye Sistemi

KODU	AÇIKLAMA	KOLİ	FIYATI
SGS120	X-PLUS60/600mm	4	95 \$

PLUS60 MAXIMUMSTRONG
STRONG AND LIGHTWEIGHT ALUMINUM BODY

Seramik & Granit Kesme Makinası

Alüminyum GövdeGüçlü ve Hassas
Rulmanlı Çift Mil
Kesim Sistemi10mm
Kalem
Elmas Uç**STRONG**
DIAMOND
CUTTER BLADEEXTRA
STRONG2YIL
GARANTİ
ÜRETİM
MÜHÜRÜ

45°

**600mm**Kırılma ve Aşınmaya Dayanıklı Kesici Kol
Ayarlanabilir Alüminyum Cetveli Gönye Sistemi

KODU	AÇIKLAMA	KOLİ	FIYATI
SGS126	PLUS60/600mm	4	85 \$

DEV120 MAXIMUMSTRONG
STRONG METAL BODY

Seramik & Granit Kesme Makinası

Metal GövdeGüçlü ve Hassas
Rulmanlı Lama
Kesim Sistemi22^S TITANIUM
COATING
TUNGSTENCARBİDE

Rulmanlı Kesme Elması

**STRONG**
DIAMOND
CUTTER BLADEEXTRA
STRONG2YIL
GARANTİ
ÜRETİM
MÜHÜRÜ

45°



Taşıma Kolu



Tekerlekli Ayaklar

Kırılma ve Aşınmaya Dayanıklı Alüminyum Kesici Kol
Ayarlanabilir Alüminyum Cetveli Gönye Sistemi

KODU	AÇIKLAMA	KOLİ	FIYATI
SGS104	DEV120/1200mm	1	250 \$

DEV Series MAXIMUMSTRONG
STRONG METAL BODYSeramik & Granit Kesme Makinası
Metal Gövde Dev135-155Güçlü ve Hassas
Rulmanlı Lama
Kesim Sistemi22MM TITANIUM
TUNGSTEN CARBIDE
Rulmanlı Kesme Elması1350mm
1550mmEXTRA
STRONG 2YIL
GARANTİ
STRONG
DIAMOND
CUTTER BLADE

Taşıma Kolu

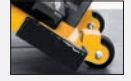

Tekerlekli Ayaklar

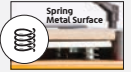
Yayı
Metal
YüzeyKırılma ve Aşınmaya Dayanıklı Alüminyum Kesici Kol
Ayarlanabilir Alüminyum Cetveli Gönye Sistemi

KODU	AÇIKLAMA	KOLI	FİYATI
SGS105	DEV135/1350mm	1	360 \$
SGS106	DEV155/1550mm	1	480 \$

LONG Series MAXIMUMSTRONG
STRONG METAL BODYSeramik & Granit Kesme Makinası
Metal Gövde Long80-100-120-160Güçlü ve Hassas
Rulmanlı Lama
Kesim Sistemi22MM TITANIUM
TUNGSTEN CARBIDE
Rulmanlı Kesme Elması-LASER
GUIDE2YIL
GARANTİ
URETİM
GARANTİ

Laser İşaretleme



Tekerlekli Ayaklar

800-1000-1200-1600mm

Kırılma ve Aşınmaya Dayanıklı Alüminyum Kesici Kol
Ayarlanabilir Cetveli Gönye Sistemi

KODU	AÇIKLAMA	KOLI	FİYATI
SGS108	LONG 80/800mm	1	153 \$
SGS107	LONG 100/1000mm	1	164 \$
SGS111	LONG 120/1200mm	1	180 \$
SGS112	LONG 160/1600mm	1	275 \$

MEGA 320

3200mm

Seramik & Granit Kesme Makinası

22MM
TUNGSTEN
CARBIDE

MAXIMUMSTRONG

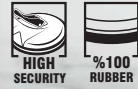
HIGH
SECURITY%100
RUBBER**Set içeriği**

- 3 Adet Alüminyum Ray
- 3 Adet Vantuz
- 1 Adet Karo Pensesi
- 1 Adet Karo Ayırıcı
- 1 Adet Kesici Mekanizma
- 1 Adet Allen Anahtar
- 2 Adet Kılavuz
- Taşıma Çantası

2YIL
GARANTİ
URETİM
GARANTİ

KODU	AÇIKLAMA	KOLI	FİYATI
SGS113	Mega/3200mm	1	345 \$

Tekli Vantuz Ø12cm

Alüminyum Gövde

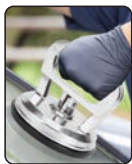

STRONG HOLD

STRONG
HOLDHIGH
SECURITY%100
RUBBERCam - Granit - Seramik - Laminat ve Aşşaz Zeminler - Aynalar her türlü temiz,
gözeneksiz yüzeylerin taşınması için uygundur.**max** / **50 kg**

KODU	AÇIKLAMA	KOLI	FİYATI
SGS954	Tekli Vantuz / Ø12cm	30	9.50 \$

İkili Vantuz Ø12cm

Alüminyum Gövde

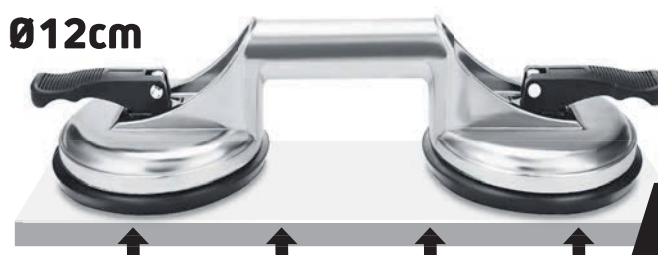
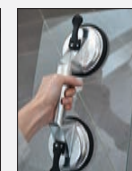
STRONG
HOLDHIGH
SECURITY%100
RUBBER2YIL
GARANTİ
URETİM
GARANTİCam - Granit - Seramik - Laminat ve Aşşaz Zeminler
Aynalar her türlü temiz, gözeneksiz yüzeylerin
taşınması için uygundur.**max** / **100 kg**

KODU	AÇIKLAMA	KOLI	FİYATI
SGS955	İkili Vantuz / Ø12cm	20	12 \$

Üçlü Vantuz

Ø12cm

Alüminyum Gövde

2YIL
GARANTİ
ÜRETİMSTRONG
HOLDHIGH
SECURITY%100
RUBBER

Cam - Granit - Seramik - Laminat ve Aşşag Zeminler
Aynalar her türlü temiz, gözeneksiz yüzeylerin
taşınması için uygundur.

max 155 kg

KODU	AÇIKLAMA	KOLİ	FIYATI
SGS956	Üçlü Vantuz/Ø12cm	12	17.50 \$

Pompa VantuzHava Pompalı
Vakum Sistemi

Ø20cm

%100
RUBBER2YIL
GARANTİ
ÜRETİM

Cam - Granit - Seramik
Laminat ve Aşşag Zeminler
Aynalar her türlü temiz,
gözeneksiz yüzeylerin
taşınması için uygundur.

**max 130 kg**

KODU	AÇIKLAMA	KOLİ	FIYATI
SGS957	Pompa Vantuz/Ø20cm	10	36 \$

Pompa VantuzHava Pompalı Vakum Sistemi
Basınç Göstergeli

Ø20cm

PRESSURE
GAUGE%100
RUBBER2YIL
GARANTİ
ÜRETİM

Cam - Granit - Seramik
Laminat ve Aşşag Zeminler
Aynalar her türlü temiz,
gözeneksiz yüzeylerin
taşınması için uygundur.

**max 150 kg**

KODU	AÇIKLAMA	KOLİ	FIYATI
SGS958	Pompa Vantuz/Ø20cm	10	40 \$

Ayarlanabilir Vantuz

Alüminyum Gövde

HIGH SECURITY

%100 RUBBER

Ø12cm



30mm

20mm

2YIL
GARANTİ
ÜRETİM

Seramik - Granit - Fayans Mermer Yer ve
Duvar Karolarının Seviyesini ve Derz Arası Boşluklarını
Ayarlamak için Kullanılır.

max 100 kg

KODU	AÇIKLAMA	KOLİ	FIYATI
SGS959	Ayarlanabilir Vantuz/Ø12cm	10	27.50 \$

Ayarlanabilir Milli VantuzHava Pompalı
Vakum Sistemi

Ø15cm

440
mm0-40mm
MAX0-20mm
MAX

Seramik - Granit - Fayans Mermer Yer ve Duvar Karolarının Seviyesini ve
Derz Arası Boşluklarını Ayarlamak için Kullanılır.

2YIL
GARANTİ
ÜRETİM**max 120 kg**

KODU	AÇIKLAMA	KOLİ	FIYATI
SGS960	Ayarlanabilir Milli Vantuz	10	79.50 \$

Şablon Cetveli**6 Açılı Katlı Alüminyum Gövde**

Ø25mm
Ø40mm
Ø45mm



Ahşap, Fayans, Döşeme, Metal ve daha fazlası için şablonlar oluşturun.

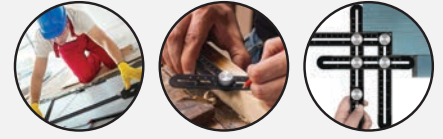

Doğru deliğin konumunu bulmak için kullanılır.
6 kenarlı cetvel ihtiyacınız olan özel açılan veya şekilleri kolayca oluşturmanızı ve ölçmenizi sağlar.



KODU	AÇIKLAMA	KOLI	FIYATI
SGS970	Şablon Cetveli	50	8.75 \$

Kalem Elmas**Seramik & Granit Kesme Elması**

8 - 10 - 12mm
Tungsten Carbide

X-PLUS60 PLUS60



KODU	AÇIKLAMA	KUTU	FIYATI
SGS130	8mm	10	6.60 \$
SGS131	10mm	10	7.20 \$
SGS132	12mm	10	7.80 \$

Elmas**Seramik & Granit Kesme Elması**

16 - 22mm
Titanyum Kaplama

PRO Series MAC Series



KODU	AÇIKLAMA	KUTU	FIYATI
SGS146	22mm	25	5.30 \$
SGS147	16mm/Pro/Mac	25	3.60 \$

Elmas**Seramik & Granit Kesme Elması**

16 - 22mm
Tungsten Carbide

PRO Series MAC Series



KODU	AÇIKLAMA	KUTU	FIYATI
SGS142	22mm	25	4.30 \$
SGS144	16mm/Pro/Mac	25	3.00 \$

Elmas**Seramik & Granit Kesme Elması**

22mm
Titanyum Kaplama

DEV Series LONG Series

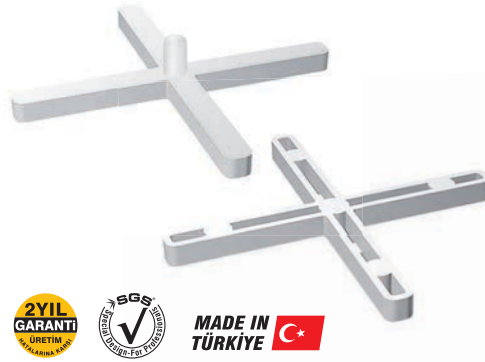
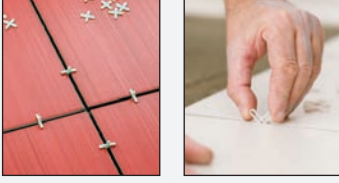

KODU	AÇIKLAMA	KUTU	FIYATI
SGS148	22mm	25	6.00 \$

Derz Artısı**Düz - Oluklu Derz Artısı**

MADE IN TÜRKİYE

Düz Derz Artısı

KODU	AÇIKLAMA	Paket/Adet	Çuval/Paket	Paket/Fiyat
SGS6152	2mm	500	50	36 ₺
SGS6153	3mm	500	50	55 ₺

Oluklu Derz Artısı

KODU	AÇIKLAMA	Paket/Adet	Çuval/Paket	Paket/Fiyat
SGS6156	3mm	500	50	35 ₺
SGS6157	4mm	500	50	65 ₺

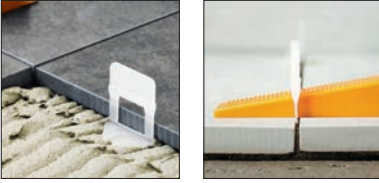
Plastik Klips**Seviye ve Derz Sistemi
Kolay ve Hızlı Uygulama**

MADE IN TÜRKİYE

Granit Mermer, Fayans gibi her türlü zemin ve duvar kaplamalarının daha kolay ve hızlı uygulanması için tasarlanmış üstün bir seviye eşitleme ve derz arası boşluk sistemidir.

KODU	AÇIKLAMA	Paket/Adet	Çuval/Paket	Paket/Fiyat
SGS6172	0.5mm	100	50	60 ₺
SGS6173	1mm	100	50	60 ₺
SGS6169	1.5mm	100	50	60 ₺
SGS6174	2mm	100	50	60 ₺
SGS6168	2.5mm	100	50	60 ₺
SGS6175	3mm	100	50	60 ₺

Plastik Takoz**Seviye ve Derz Sistemi
Kolay ve Hızlı Uygulama**

MADE IN TÜRKİYE

Granit Mermer, Fayans gibi her türlü zemin ve duvar kaplamalarının daha kolay ve hızlı uygulanması için tasarlanmış üstün bir seviye eşitleme ve derz arası boşluk sistemidir.

KODU	AÇIKLAMA	Paket/Adet	Çuval/Paket	Paket/Fiyat
SGS6167	Siyah	100	25	110 ₺
SGS6176	Sarı	100	25	140 ₺

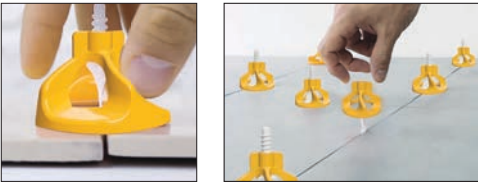
Plastik Vidalı Klips**Seviye ve Derz Sistemi
Kolay ve Hızlı Uygulama**

MADE IN TÜRKİYE

Granit Mermer, Fayans gibi her türlü zemin ve duvar kaplamalarının daha kolay ve hızlı uygulanması için tasarlanmış üstün bir seviye eşitleme ve derz arası boşluk sistemidir.

KODU	AÇIKLAMA	Paket/Adet	Çuval/Paket	Paket/Fiyat
SGS6401	1mm	100	50	70 ₺
SGS6404	1.5mm	100	50	70 ₺
SGS6402	2mm	100	50	70 ₺
SGS6405	2.5mm	100	50	70 ₺
SGS6403	3mm	100	50	70 ₺

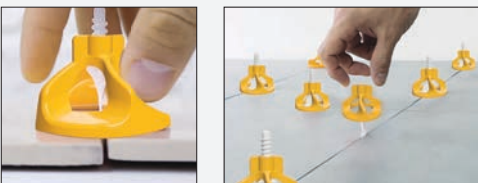
Plastik Vidalı Takoz**Seviye ve Derz Sistemi
Kolay ve Hızlı Uygulama**

MADE IN TÜRKİYE

Granit Mermer, Fayans gibi her türlü zemin ve duvar kaplamalarının daha kolay ve hızlı uygulanması için tasarlanmış üstün bir seviye eşitleme ve derz arası boşluk sistemidir.

KODU	AÇIKLAMA	Paket/Adet	Çuval/Paket	Paket/Fiyat
SGS6406	Sarı	100	25	130 ₺

Ayar Pensesi**Seviye ve Derz Sistemi**
Kolay ve Hızlı Uygulama

MADE IN TÜRKİYE

Plastik Gövde

Seviye tespit pensesi özel ayarlanabilir yapısı sayesinde takozların seviye tespit artıklarına yerleştirilmesini kolaylaştırmak ve montajı hızlandırmak için kullanılır.



KODU	AÇIKLAMA	KOLİ	FIYATI
SGS6177	Ayar Pensesi	24	150 ₺

Ayar Pensesi**Seviye ve Derz Sistemi**
Kolay ve Hızlı Uygulama

MADE IN TÜRKİYE

Metal Gövde

Seviye tespit pensesi özel ayarlanabilir yapısı sayesinde takozların seviye tespit artıklarına yerleştirilmesini kolaylaştırmak ve montajı hızlandırmak için kullanılır.



KODU	AÇIKLAMA	KOLİ	FIYATI
SGS6185	Ayar Pensesi	24	200 ₺

Derz Kazıma Aparatı**Güçlü Plastik Gövde**

Eskimiş, kırılmış derzleri kazımak için kullanılır.

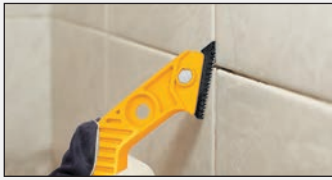

Derz İspatulası



Metal Çift Bıçak



MADE IN TÜRKİYE



KODU	AÇIKLAMA	KOLİ	FIYATI
SGS6186	Derz Kazıma Aparatı	24	50 ₺

Lastik Tokmak**Güçlü Plastik Gövde**

EXTRA STRONG



Seramik, Fayans,
Yer Karosu ve Zemin
Döşeme Uygulamasında
Kullanılır.



MADE IN TÜRKİYE

No 50 - No 60

KODU	AÇIKLAMA	KOLİ	FIYATI
SGS109	No 50	12	125 ₺
SGS110	No 60	12	150 ₺

Duvar Kağıdı İspatulası**Esnemeye Dayanıklı Güçlü Plastik Gövde**

MADE IN TÜRKİYE

Tip Type	A (mm)	B (mm)	C (mm)	
17x27,5x20	170	275	200	

KODU	AÇIKLAMA	KOLİ	FIYATI
SGS985	D.Kağıdı İspatulası	24	45 ₺

Elastik Kova 16lt**Ekstra Esnek Plastik Gövde**EXTRA
FLEXIBLEMADE IN
TÜRKİYE

Tip Type	A (mm)	B (mm)	C (mm)	ØA ØB
35x24x24,5	355	240	245	

Genel amaçlı olup, başlıca kullanım alanları, inşaat harcı taşıması, karıştırması ve temizlik işleri için uygundur.

KODU	AÇIKLAMA	KOLİ	FIYATI
SGS988	Elastik Kova	12	150 ₺

Sıva ve Alçı Teknesi**Esnemeye Dayanıklı
Güçlü Plastik Gövde****35lt SARI**MADE IN
TÜRKİYE

Genel amaçlı olup, başlıca kullanım alanları, inşaat harcı taşıması, karıştırması ve temizlik işleri için uygundur.

Tip- Type (mm)	A (mm)	B (mm)	C (mm)	B/C
35lt 640x430x185	640	430	185	

KODU	AÇIKLAMA	KOLİ	FIYATI
SGS987	35lt Tekne	12	280 ₺

Sıva ve Alçı Teknesi**Esnemeye Dayanıklı
Güçlü Plastik Gövde****35lt SIYAH**MADE IN
TÜRKİYE

Genel amaçlı olup, başlıca kullanım alanları, inşaat harcı taşıması, karıştırması ve temizlik işleri için uygundur.

Tip- Type (mm)	A (mm)	B (mm)	C (mm)	B/C
35lt 640x430x185	640	430	185	

KODU	AÇIKLAMA	KOLİ	FIYATI
SGS991	35lt Tekne	12	200 ₺

Sıvacı Küreği**Esnemeye Dayanıklı
Güçlü Plastik Gövde**Kırmızı-Sarı
355x440mmMADE IN
TÜRKİYE

KODU	AÇIKLAMA	AÇIKLAMA	FIYATI
SGS983	KIRMIZI	12	200 ₺
SGS995	SARI	12	200 ₺

Serpme Küreği**Esnemeye Dayanıklı
Güçlü Plastik Gövde****20x40cm**MADE IN
TÜRKİYE

Tip Type	A (mm)	B (mm)	C (mm)	A/B
21,5x20x40	215	200	400	

KODU	AÇIKLAMA	KOLİ	FIYATI
SGS986	Serpme Küreği	12	60 ₺

Alçı Malası**Kauçuk Saplı**
30 - 35cm0.70 mm Kalınlığında Polisajlı
50 Rockwell Yay ÇeliğiExtra Dayanıklı İki Komponentli Özel Plastik
Malzemeden Üretilmiş Ergonomik Sap

KODU	AÇIKLAMA	KOLİ	FIYATI
SGS3600	30cm	12	140 ₺
SGS3601	35cm	12	150 ₺

Seramik Malası**Kauçuk Saplı**
30 - 35cm0.70 mm Kalınlığında Polisajlı
50 Rockwell Yay ÇeliğiExtra Dayanıklı İki Komponentli Özel Plastik
Malzemeden Üretilmiş Ergonomik Sap

KODU	AÇIKLAMA	KOLİ	FIYATI
SGS3605	8x8 Diş/30cm	12	140 ₺
SGS3606	8x8 Diş/35cm	12	150 ₺
SGS3607	10x10 Diş/30cm	12	140 ₺
SGS3608	10x10 Diş/35cm	12	150 ₺

Alçı Malası**Kauçuk Saplı**
40 - 50cm0.70 mm Kalınlığında Polisajlı
50 Rockwell Yay ÇeliğiExtra Dayanıklı İki Komponentli Özel Plastik
Malzemeden Üretilmiş Ergonomik Sap

KODU	AÇIKLAMA	KOLİ	FIYATI
SGS3602	40cm	12	165 ₺
SGS3603	50cm	12	175 ₺

Seramik Malası**Kauçuk Saplı**
40 - 50cm0.70 mm Kalınlığında Polisajlı
50 Rockwell Yay ÇeliğiExtra Dayanıklı İki Komponentli Özel Plastik
Malzemeden Üretilmiş Ergonomik Sap

KODU	AÇIKLAMA	KOLİ	FIYATI
SGS3609	8x8 Diş/40cm	12	160 ₺
SGS3610	8x8 Diş/50cm	12	170 ₺
SGS3611	10x10 Diş/40cm	12	160 ₺
SGS3612	10x10 Diş/50cm	12	170 ₺

Alçı Malası**Plastik Saplı**
30 - 35cm0.70 mm Kalınlığında Polisajlı
50 Rockwell Yay ÇeliğiExtra Dayanıklı Özel Plastik
Malzemeden Üretilmiş Ergonomik Sap

KODU	AÇIKLAMA	KOLİ	FIYATI
SGS1910	30cm	12	120 ₺
SGS1911	35cm	12	125 ₺

Seramik Malası**Plastik Saplı****30 - 35cm**0.70 mm Kalınlığında Polısajlı
50 Rockwell Yay Çeliđi**MADE IN TÜRKİYE**Extra Dayanıklı Özel Plastik
Malzemeden Üretilmiş Ergonomik Sap

KODU	AÇIKLAMA	KOLİ	FİYATI
SGS1915	8x8 Diş/30cm	12	120 ₺
SGS1916	8x8 Diş/35cm	12	125 ₺
SGS1917	10x10 Diş/30cm	12	120 ₺
SGS1918	10x10 Diş/35cm	12	125 ₺

Süngerli Mala**Esnemeye Dayanıklı
Güçlü Plastik Gövde**Özel Sünger
Taban**MADE IN TÜRKİYE****175x245mm**Extra Dayanıklı İki Komponentli Özel Plastik
Malzemeden Üretilmiş Ergonomik Sap

KODU	AÇIKLAMA	KOLİ	FİYATI
SGS1251	Süngerli Mala	12	150 ₺

Kauçuk Mala**Esnemeye Dayanıklı
Güçlü Plastik Gövde**Özel Kauçuk
Taban**MADE IN TÜRKİYE****140x280mm**Extra Dayanıklı İki Komponentli Özel Plastik
Malzemeden Üretilmiş Ergonomik Sap

KODU	AÇIKLAMA	KOLİ	FİYATI
SGS1252	Kauçuk Mala	12	200 ₺

Derz Malası**Esnemeye Dayanıklı
Güçlü Plastik Gövde**Özel Kauçuk
Taban**MADE IN TÜRKİYE**Extra Dayanıklı İki Komponentli Özel Plastik
Malzemeden Üretilmiş Ergonomik Sap

KODU	AÇIKLAMA	KOLİ	FİYATI
SGS1254	Kısa Derz Malası/115x280mm	12	135 ₺
SGS1255	Uzun Derz Malası/115x385mm	12	150 ₺

Tırfıl Malası**Esnemeye Dayanıklı
Güçlü Plastik Gövde**Özel Kauçuk
Taban**MADE IN TÜRKİYE**Extra Dayanıklı İki Komponentli Özel Plastik
Malzemeden Üretilmiş Ergonomik Sap

KODU	AÇIKLAMA	KOLİ	FİYATI
SGS981	Kısa Tırfıl Malası/150x225mm	12	125 ₺
SGS982	Uzun Tırfıl Malası/100x375mm	12	140 ₺

Kaleterasit Malası**Esnemeye Dayanıklı
Güçlü Plastik Gövde****MADE IN TÜRKİYE****125x275mm**Extra Dayanıklı Özel Plastik
Malzemeden Üretilmiş Ergonomik Sap

KODU	AÇIKLAMA	KOLİ	FİYATI
SGS998	Kaleterasit Malası	12	75 ₺

Kaleterasit Malası**Esnemeye Dayanıklı
Güçlü ABS Plastik Gövde****MADE IN TÜRKİYE****140x280mm**Extra Dayanıklı Özel Plastik
Malzemeden Üretilmiş Ergonomik Sap

KODU	AÇIKLAMA	KOLİ	FİYATI
SGS990	Kaleterasit Malası	12	100 ₺

Boyacı İspatulası**0.80 mm Kalınlığında Polisajlı
50 Rockwell Yay Çeliği****MADE IN TÜRKİYE**

KODU	AÇIKLAMA	Paket/ Koli	FİYATI
SGS681	30mm	12/180	30 ₺
SGS682	40mm	12/180	32 ₺
SGS683	50mm	12/180	34 ₺
SGS684	60mm	12/180	36 ₺
SGS685	70mm	12/180	38 ₺
SGS686	80mm	12/180	40 ₺
SGS687	90mm	12/180	42 ₺
SGS688	100mm	12/180	44 ₺
SGS689	120mm	12/180	46 ₺

Saptak İspatula**0.70 mm Kalınlığında Polisajlı
50 Rockwell Yay Çeliği****8-10-12-14cm**Plastik Sap Kısmı Sırkı Takmak
İçin Uygundur**MADE IN TÜRKİYE**Her Türlü Alçı, Macun ve
Kazıma Uygulamalarında Kullanılır.

KODU	AÇIKLAMA	KOLİ	FİYATI
SGS1900	8cm	12	51 ₺
SGS1901	10cm	12	54 ₺
SGS1902	12cm	12	57 ₺
SGS1903	14cm	12	60 ₺

Kazıma Raspa**Esnemeye Dayanıklı
Güçlü Metal Gövde****10-20-30cm**Sap Kısmı Sırkı Takmak
İçin Uygundur**MADE IN TÜRKİYE**Korozyonu Önleyen
1. Sınıf Elektrostatik Boya

KODU	AÇIKLAMA	KOLİ	FİYATI
SGS406	10cm	12	100 ₺
SGS407	20cm	12	120 ₺
SGS408	30cm	12	150 ₺

Sıva Malası

1.20mm Kalınlığında
Zımparalanmış 50 Rockwell Yay Çeliği



Sap Kısmı Özel Kaynak Sistemi ile
Kaynatılmıştır

Gürgen Ağaçtan
Vernikli
Ahşap Sap



KODU	AÇIKLAMA	KOLİ	FİYATI
SGS380	16cm	12	85 ₺
SGS382	18cm	12	90 ₺
SGS383	20cm	12	95 ₺
SGS384	22cm	12	100 ₺
SGS385	24cm	12	105 ₺
SGS386	26cm	12	110 ₺

Duvarcı Malası

1.20mm Kalınlığında
Zımparalanmış 50 Rockwell Yay Çeliği



Sap Kısmı Özel Kaynak Sistemi ile
Kaynatılmıştır

Gürgen Ağaçtan
Vernikli
Ahşap Sap



Duvar Örmeye ve Her Türü İnşaat
Uygulamalarında Kullanılır

KODU	AÇIKLAMA	AÇIKLAMA	FİYATI
SGS390	No 20	12	95 ₺

Macun İspatulası

0.70mm Kalınlığında
Zımparalanmış 50 Rockwell Yay Çeliği

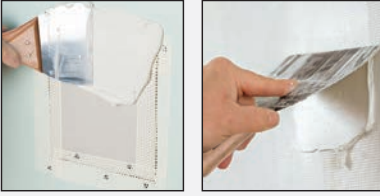

Fırınlanmış
Kayın Ağacından
Vernikli
Ahşap Sap



Her Türü Alçı ve Macun
Uygulamalarında Kullanılır



KODU	AÇIKLAMA	KOLİ	FİYATI
SGS371	6cm	12	90 ₺
SGS372	8cm	12	95 ₺
SGS373	10cm	12	100 ₺
SGS374	12cm	12	105 ₺
SGS375	14cm	12	110 ₺
SGS376	18cm	12	120 ₺

Macun Küreği

0.70 mm Kalınlığında Polijalı
50 Rockwell Yay Çeliği



Fırınlanmış
Kayın
Ağacından
Vernikli
Ahşap Sap



18-20cm

Her Türü Alçı ve Macun
Uygulamalarında Kullanılır.

KODU	AÇIKLAMA	KOLİ	FİYATI
SGS404	18cm	12	175 ₺
SGS405	20cm	12	185 ₺

Çelik Sistre

0.50 mm
Kalınlığında Polijalı
50 Rockwell
Çelikten Üretilmiştir

6x15cm



KODU	AÇIKLAMA	KOLİ	FİYATI
SGS409	Çelik Sistre	24	25 ₺
SGS410	Çelik Sistre Paslanmaz	24	40 ₺

Kestirme Fırça**Plastik Sap**

Paslanmaz
Nikel Çerçeve

Kıl
Bırakmaz

Kolay
Temizlenir



MADE IN TÜRKİYE

KODU	AÇIKLAMA	Paket / Koli	FIYATI
SGS4100	1.0"	24/240	17 ₺
SGS4101	1.5"	24/240	20 ₺
SGS4102	2.0"	24/240	27 ₺
SGS4103	2.5"	12/120	36 ₺
SGS4104	3.0"	12/120	42 ₺
SGS4105	4.0"	12/120	50 ₺

Robot Fırça**Plastik Sap**

Paslanmaz
Nikel Çerçeve

Kıl
Bırakmaz

Kolay
Temizlenir

180° Hareket
Kabiliyeti

Sırk Takmak İçin
Uygun



MADE IN TÜRKİYE

KODU	AÇIKLAMA	Paket / Koli	FIYATI
SGS4123	3.0"	12/120	72 ₺
SGS4124	4.0"	12/120	80 ₺

Kestirme Fırça**Ahşap Sap**

Paslanmaz Nikel Çerçeve

Kıl Bırakmaz

Kolay Temizlenir



MADE IN TÜRKİYE

KODU	AÇIKLAMA	Paket / Koli	FIYATI
SGS4113	3.0"	12/120	65 ₺
SGS4114	4.0"	12/120	75 ₺

Saten Rulo**20-25cm**

Saten ve Su Bazlı Boyalarda
Kullanıma Uygun.

Kullanıldıktan
Performansı
Artar.



MADE IN TÜRKİYE

Özel İplikten Üretilmiş Uzun Ömürlü Kumaş

KODU	AÇIKLAMA	KOLİ	FIYATI
SGS6020	20cm	25	80 ₺
SGS6025	25cm	25	85 ₺

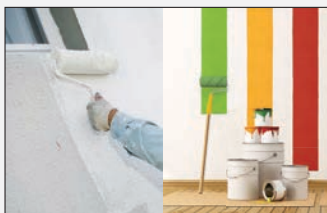
İç ve Dış Cephe Rulosu**20-25cm**

Plastik İç ve Dış Cephe
Boyalarda Kullanıma
Uygun.

Kullanıldıktan
Performansı Artar.



MADE IN TÜRKİYE

Özel İplikten Üretilmiş Uzun Ömürlü Kumaş

KODU	AÇIKLAMA	KOLİ	FIYATI
SGS6120	20cm	25	80 ₺
SGS6125	25cm	25	85 ₺

Parmak Rulo**10cm**

Saten ve Su Bazlı Boyalarda
Kullanıma Uygundur.

Kullanıldıkça
Performansı Artar.

Özel İplikten Üretilmiş
Uzun Ömürlü Kumaş

**Parmak Rulo 10 cm**

KODU	AÇIKLAMA	KOLİ	FIYATI
SGS6010	10cm	50	50 ₺

Parmak Rulo Yedeği

KODU	AÇIKLAMA	Kutu / Koli	FIYATI
SGS6011	10cm	25/500	15 ₺

Çalı Fırçası**Güçlü Plastik Takoz**

Güçlü Polipropilen Kılar

Ekstra Sert Kılar

KODU	AÇIKLAMA	KOLİ	FIYATI
SGS4190	30cm	12	70 ₺
SGS4191	40cm	12	90 ₺
SGS4192	50cm	12	110 ₺
SGS4193	60cm	12	130 ₺

Oto Fırçası**Güçlü Plastik Siyah Takoz**

100 % Doğa Dostu Pet Fırça Kılı
Hortum Bağlantılı

**Ekstra Yumuşak Doku**

KODU	AÇIKLAMA	KOLİ	FIYATI
SGS4166	Oto Fırçası	12	55 ₺

Oto Fırçası**Güçlü Plastik Sarı Takoz**

100 % Doğa Dostu Pet Fırça Kılı
Hortum Bağlantılı
Renkli Kutu

**Ekstra Yumuşak Doku**

KODU	AÇIKLAMA	KOLİ	FIYATI
SGS4165	Oto Fırçası	12	70 ₺

Yer Fırçası**Güçlü Plastik Sarı Takoz**

100 % Doğa Dostu Pet Fırça Kılı
Yer ve zemin temizliklerinde kullanılır.

**Yumuşak Doku**

KODU	AÇIKLAMA	KOLİ	FIYATI
SGS4170	Yer Fırçası	12	55 ₺

Halı Fırçası**Güçlü Plastik Sarı Təköz**

Güçlü Polipropilen Kollar
Halı ve sert zemin temizliđi uygulamaları için kullanılabilir.

**Ekstra Sert Kollar**

MADE IN TÜRKİYE

KODU	AÇIKLAMA	KOLİ	FIYATI
SGS4175	Halı Fırçası	12	55 ₺

Badana Fırçası**Güçlü Plastik Sarı Təköz**

Özel Yele Kollar
Su bazlı boya ve badana işlerinde kullanılır.

**Kıl Bırakmaz Özel Yele**

MADE IN TÜRKİYE

KODU	AÇIKLAMA	KOLİ	FIYATI
SGS4185	Badana Fırçası	12	100 ₺

Badana Fırçası**Ahşap Təköz**

Özel Yele Kollar
Su bazlı boya ve badana işlerinde kullanılır.

**Kıl Bırakmaz Özel Yele**

MADE IN TÜRKİYE

KODU	AÇIKLAMA	KOLİ	FIYATI
SGS4180	Badana Fırçası	12	120 ₺

Serpme Fırçası**Güçlü Plastik Sarı Təköz**

100 % Dođa Dostu Pet Fırça Kılı
Sıva Öncesi ve Sonrası Perdahlama İşleminde Duvara Su Atılması İçin Kullanılır.



Sap Gövdeye Vidalı Olarak Montajlanır

170x60mm

Yumuşak Doku

MADE IN TÜRKİYE

KODU	AÇIKLAMA	KOLİ	FIYATI
SGS4160	Serpme Fırça	12	50 ₺

Çekpas 40-55cm**Güçlü Plastik Gövde****Yumuşak Kauçuk**

MADE IN TÜRKİYE

KODU	AÇIKLAMA	KOLİ	FIYATI
SGS4150	40cm	12	70 ₺
SGS4151	55cm	12	80 ₺

Rulo Izgarası**21x29cm**

Damlatmayı
Önleyen Sık
Gözenekli
Tasarım

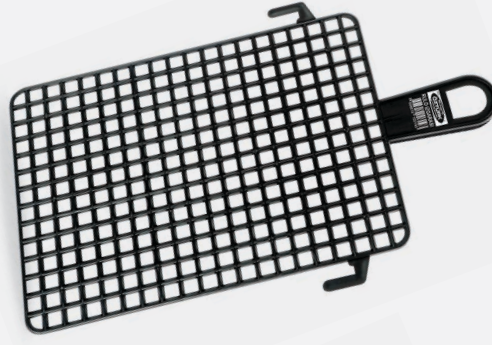
**MADE IN TÜRKİYE**

KODU	AÇIKLAMA	Paket/ Koli	FİYATI
SGS381	Rulo Izgarası	12/120	25 ₺

Rulo Izgarası**26x30cm**

Damlatmayı
Önleyen Sık
Gözenekli
Tasarım

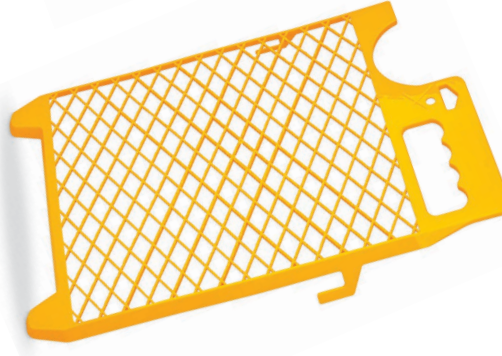
**MADE IN TÜRKİYE**

KODU	AÇIKLAMA	KOLİ	FİYATI
SGS379	Rulo Izgarası	50	30 ₺

Hışır Örtü**Koruyucu**

Boya Dökülmesine
Suya ve Toza Karşı
Tam Koruma

**MADE IN TÜRKİYE**

KODU	AÇIKLAMA	KOLİ	FİYATI
SGS4001	4 x 2,5 = 10m ²	60	21 ₺
SGS4002	4 x 5 = 20m ²	30	29 ₺
SGS4003	4 x 7,5 = 30m ²	18	45 ₺
SGS4005	4 x 12,5 = 50m ²	12	63 ₺

Kalın Zemin Örtü**Koruyucu**

Boya Dökülmesine
Suya ve Toza Karşı
Tam Koruma

**MADE IN TÜRKİYE**

KODU	AÇIKLAMA	KOLİ	FİYATI
SGS4010	4 x 2,5 = 10m ²	50	31 ₺
SGS4011	4 x 5 = 20m ²	40	50 ₺
SGS4012	4 x 7,5 = 30m ²	30	70 ₺
SGS4013	4 x 12,5 = 50m ²	20	104 ₺

Boyalı Çırpı İpi**Mavi - Kırmızı****30 Metre Uzunluğunda Çırpı İpi**

115gr Renkli Toz Boya

İpe Takiılan Su Terazisi

KODU	AÇIKLAMA	Paket/ Koli	FİYATI
SGS1000	Kırmızı	12/48	2.20 \$
SGS1001	Sarı	12/48	2.20 \$

Sabit Sırık Metal 120-150cm

0,40mm Güçlü Metal Gövde



Her Türlü Süpürge, Rulo ve Fırça Saplarına Uygundur.

KODU	AÇIKLAMA	KOLİ	FİYATI
SGS6200	120cm	20	50 ₺
SGS6211	150cm	20	60 ₺

Teleskopik Sırık Metal 1,5-2-3-4 Metre

Boyu İstenilen Uzunluğa Ayarlanabilir

0,40mm Güçlü Metal Gövde



Her Türlü Süpürge, Rulo ve Fırça Saplarına Uygundur.

KODU	AÇIKLAMA	KOLİ	FİYATI
SGS6201	1,5 Metre	10	90 ₺
SGS6202	2 Metre	10	100 ₺
SGS6203	3 Metre	10	140 ₺
SGS6204	4 Metre	10	180 ₺

Teleskopik Sırık Alüminyum 1,5-2-3-4 Metre

Boyu İstenilen Uzunluğa Ayarlanabilir

1,00mm Güçlü Elokсалlı Alüminyum Gövde



Her Türlü Süpürge, Rulo ve Fırça Saplarına Uygundur.

KODU	AÇIKLAMA	KOLİ	FİYATI
SGS6205	1,5 Metre	10	200 ₺
SGS6206	2 Metre	10	250 ₺
SGS6207	3 Metre	10	350 ₺
SGS6208	4 Metre	10	450 ₺

Blade Mix  SDS Plus

Boya & Alçı Karıştırıcı



Uzun Ömür

Krom Kaplama

Boya, Vernik, Alçı Vb. Malzemelerin Karıştırılmasına Uygun Olarak Üretilmiştir



KODU	AÇIKLAMA	KOLİ	FİYATI
SGS265	80x400mm	20	75 ₺
SGS266	100x450mm	20	85 ₺
SGS267	120x500mm	20	95 ₺

High Mix  SDS Plus

Boya & Alçı Tutkal Karıştırıcı



Uzun Ömür

Krom Kaplama

Boya, Vernik, Alçı Vb. Malzemelerin Karıştırılmasına Uygun Olarak Üretilmiştir



KODU	AÇIKLAMA	KOLİ	FİYATI
SGS269	120x600mm	12	110 ₺

M14 Mix **M-14** Bağlantı Dişlisi 

Boya & Alçı Tutkal Karıştırıcı



Uzun Ömür

Krom Kaplama

Boya, Vernik, Alçı Vb. Malzemelerin Karıştırılmasına Uygun Olarak Üretilmiştir



KODU	AÇIKLAMA	KOLİ	FİYATI
SGS270	120x600mm	12	200 ₺



Turbo Elmas Testere

Turbo Diamond Blade

115-180mm

Ultra Ince



Seramik / Granit / Porselen / Mermer



Ultra Ince Turbo Diamond Blade

ULTRA THIN
Smooth Cutting



SGS[®]

Professional Hand Tools

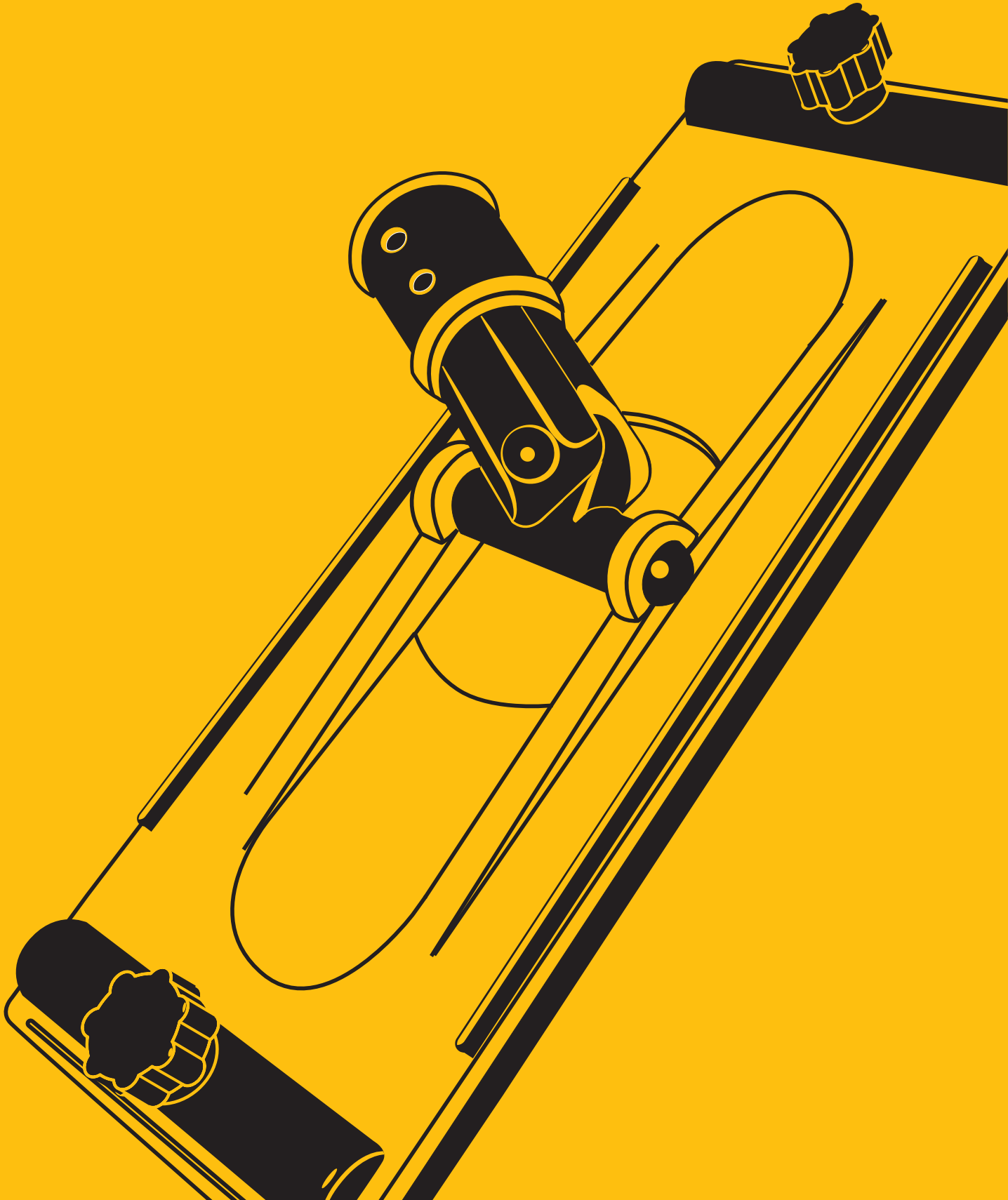

Robot Zımpara Malası



Zımparayı
Sıkıştırın Somunlu
Güçlü Çeneler



6mm Kalınlığında
Yumuşak Pad



360° Hareket Kabiliyeti Vidalı Saplara Uygun Dişli
Sağlayan Mafsalsı Sistemi Bağlantı Kovanı

KODU	AÇIKLAMA	KOLİ	FİYATI
SGS1112	Zımpara Malası	12	85 ₺

Sabit Zımpara Malası



Zımparayı
Sıkıştırın Somunlu
Güçlü Çeneler



6mm Kalınlığında
Yumuşak Pad



Kavrama Kabiliyeti Sağlayan Ergonomik Sap

KODU	AÇIKLAMA	KOLİ	FİYATI
SGS1111	Zımpara Malası	12	85 ₺

Cırtlı Disk Zımpara Tabanı

115-125-150-180mm



M14 Makina
Bağlantı Somunu

Zımpara
Takılabilen
Cırtlı Yüzey

Uygulanan Yüze
Göre Esneyen Yumuşak Pad



KODU	AÇIKLAMA	KOLİ	FİYATI
SGS285	115mm	50	33 ₺
SGS287	125mm	50	45 ₺
SGS290	150mm	25	66 ₺
SGS286	180mm	20	85 ₺

Pasta Polisaj Süngeri

150/MM Cırtlı Ped



Yumuşak Yüzey Hızlı Uygulama

Otomobil, yat, tekne, küvet ve mobilya gibi ürünlerin pasta işlemlerinde parlatma ve çizik sorunlarının giderilmesinde kullanılır.



KODU	AÇIKLAMA	KOLİ	FİYATI
SGS295	Pasta Polisaj Süngeri	24	3.00 \$

Pasta Polisaj Süngeri

150/MM Yumurta Ped



Yumuşak Yüzey Hızlı Uygulama

Otomobil, yat, tekne, küvet ve mobilya gibi ürünlerin pasta işlemlerinde parlatma ve çizik sorunlarının giderilmesinde kullanılır.



KODU	AÇIKLAMA	KOLİ	FİYATI
SGS296	Pasta Polisaj Süngeri	24	3.00 \$

Pasta Polısaj Süngeri

150/MM M14 Makına Bağlantı Somunu



MADE IN TÜRKİYE



Yumuşak Yüzey Hızlı Uygulama

Otomobil, yat, tekne, küvet ve mobilya gibi ürünlerin pasta işlemlerinde parlatma ve çizik sorunlarının giderilmesinde kullanılır.

KODU	AÇIKLAMA	KOLİ	FİYATI
SGS294	Pasta Polısaj Süngeri	12	4.00 \$

Matkap Adaptörü



M-14
Matkap Bağlantı
Adaptörü



MADE IN TÜRKİYE



Taşlama, havalı taşlama, elektrikli ve akülü matkaplar gibi çoğu döner alet türü için uygundur.

KODU	AÇIKLAMA	KOLİ	FİYATI
SGS260	Matkap Adaptörü/M-14	12	0.70 \$

Cırtlı Zımpara

Aluminium Oxide

115-125-180mm

fast
STRONG



Cırtlı Zımpara 115mm

KODU	AÇIKLAMA	Paket/Koli	FİYATI
SGS393	P40 KUM	100/1000	0.10 \$
SGS394	P60 KUM	100/1000	0.10 \$
SGS395	P80 KUM	100/1000	0.10 \$
SGS396	P100 KUM	100/1000	0.10 \$
SGS397	P120 KUM	100/1000	0.10 \$
SGS398	P150 KUM	100/1000	0.10 \$
SGS399	P180 KUM	100/1000	0.10 \$
SGS400	P220 KUM	100/1000	0.10 \$

Yüksek Performans
Uzun Ömür



Cırtlı Zımpara 125mm

KODU	AÇIKLAMA	Paket/Koli	FİYATI
SGS412	P40 KUM	100/1000	0.12 \$
SGS413	P60 KUM	100/1000	0.12 \$
SGS414	P80 KUM	100/1000	0.12 \$
SGS415	P100 KUM	100/1000	0.12 \$
SGS416	P120 KUM	100/1000	0.12 \$
SGS417	P150 KUM	100/1000	0.12 \$
SGS418	P180 KUM	100/1000	0.12 \$
SGS419	P220 KUM	100/1000	0.12 \$

Ahşap, Plastik ve Metal Malzemelerde Yüksek Talaş Kaldırma ve Yüzey Polısajına Uygun Kolay Çalışma.



Cırtlı Zımpara 180mm

KODU	AÇIKLAMA	Paket/Koli	FİYATI
SGS420	P40 KUM	100/500	0.22 \$
SGS421	P60 KUM	100/500	0.22 \$
SGS422	P80 KUM	100/500	0.22 \$
SGS423	P100 KUM	100/500	0.22 \$
SGS424	P120 KUM	100/500	0.22 \$
SGS448	P150 KUM	100/500	0.22 \$
SGS449	P180 KUM	100/500	0.22 \$
SGS450	P220 KUM	100/500	0.22 \$

Cırtlı Zımpara**Aluminium Oxide - Delikli****115-150-225mm****fast
STRONG****Cırtlı Zımpara 8 Delikli 115mm**

KODU	AÇIKLAMA	Paket / Koli	FIYATI
SGS440	P40 KUM	100/1000	0.10 \$
SGS441	P60 KUM	100/1000	0.10 \$
SGS442	P80 KUM	100/1000	0.10 \$
SGS443	P100 KUM	100/1000	0.10 \$
SGS444	P120 KUM	100/1000	0.10 \$

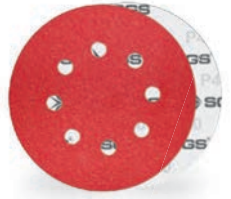
**Yüksek Performans
Uzun Ömür****Delikli
Hole**

Ahşap, Plastik ve Metal Malzemelerde Yüksek Talaş Kaldırma ve Yüzey Polijasına Uygun Kolay Çalışma.

**Cırtlı Zımpara 6 Delikli 150mm**

SGS425	P40 KUM	100/1000	0.20 \$
SGS426	P60 KUM	100/1000	0.20 \$
SGS427	P80 KUM	100/1000	0.20 \$
SGS428	P100 KUM	100/1000	0.20 \$
SGS429	P120 KUM	100/1000	0.20 \$
SGS490	P150 KUM	100/1000	0.20 \$
SGS491	P180 KUM	100/1000	0.20 \$
SGS492	P220 KUM	100/1000	0.20 \$

Cırtlı Zımpara 8+1 Delikli 225mm

SGS435	P60 KUM	100/500	0.36 \$
SGS436	P80 KUM	100/500	0.36 \$
SGS437	P100 KUM	100/500	0.36 \$
SGS438	P120 KUM	100/500	0.36 \$
SGS439	P150 KUM	100/500	0.36 \$
SGS445	P180 KUM	100/500	0.36 \$
SGS446	P220 KUM	100/500	0.36 \$
SGS447	P320 KUM	100/500	0.36 \$

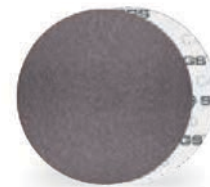
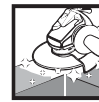
Cırtlı Zımpara**Silicone Carbide****115mm****fast
STRONG**

Taş, Mermer ve Seramik Malzemelerde Yüksek Talaş Kaldırma ve Yüzey Polijasına Uygun Kolay Çalışma.

**Yüksek Performans
Uzun Ömür****Cırtlı Zımpara 115mm**

SGS460	P40 KUM	100/1000	0.13 \$
SGS461	P60 KUM	100/1000	0.13 \$
SGS462	P80 KUM	100/1000	0.13 \$
SGS463	P100 KUM	100/1000	0.13 \$
SGS464	P120 KUM	100/1000	0.13 \$
SGS465	P150 KUM	100/1000	0.13 \$
SGS466	P180 KUM	100/1000	0.13 \$
SGS467	P220 KUM	100/1000	0.13 \$

Flap Disk**Aluminium Oxide**
115-180mm

Kavisli Yüzey Teması 8° Açılı Kanatlar
15°-25°

Çelik ve Metallerin
Taşlanması ve Yüzeylerin
Temizlenmesi İçin Kullanılır.

Flap Disk 115mm

KODU	AÇIKLAMA	Paket/Koli	FİYATI
SGS430	P40 KUM	20/200	0.80 \$
SGS431	P60 KUM	20/200	0.80 \$
SGS432	P80 KUM	20/200	0.80 \$
SGS433	P100 KUM	20/200	0.80 \$
SGS434	P120 KUM	20/200	0.80 \$

Flap Disk 180mm

KODU	AÇIKLAMA	Paket/Koli	FİYATI
SGS451	P40 KUM	10/100	2.20 \$
SGS452	P60 KUM	10/100	2.20 \$
SGS453	P80 KUM	10/100	2.20 \$
SGS454	P100 KUM	10/100	2.20 \$
SGS455	P120 KUM	10/100	2.20 \$

Flap Disk**Zirconium**
115-180mm

Kavisli Yüzey Teması 8° Açılı Kanatlar
15°-25°

Çelik ve Metallerin
Taşlanması ve Yüzeylerin
Temizlenmesi İçin Kullanılır.

Flap Disk 115mm

KODU	AÇIKLAMA	Paket/Koli	FİYATI
SGS471	Z40 KUM	20/200	0.90 \$
SGS472	Z60 KUM	20/200	0.90 \$
SGS473	Z80 KUM	20/200	0.90 \$
SGS474	Z100 KUM	20/200	0.90 \$
SGS475	Z120 KUM	20/200	0.90 \$

Flap Disk 180mm

KODU	AÇIKLAMA	Paket/Koli	FİYATI
SGS481	Z40 KUM	10/100	2.50 \$
SGS482	Z60 KUM	10/100	2.50 \$
SGS483	Z80 KUM	10/100	2.50 \$
SGS484	Z100 KUM	10/100	2.50 \$
SGS485	Z120 KUM	10/100	2.50 \$

INOX STAINLESS
STEEL**115-125-180-230mm****Fast CUT****Yüksek Performans Uzun Ömür**

KODU	AÇIKLAMA	Paket/Koli	FİYATI
SGS2150	115mm x 1mm	50/400	0.30 \$
SGS2153	125mm x 1mm	50/400	0.35 \$
SGS2151	180mm x 1.6mm	50/200	0.90 \$
SGS2152	230mm x 2mm	50/100	1.50 \$

Turbo Fiber Disk**Zımpara** Silicone Carbide**115-180mm**

Hızlı Aşındırma

Ekstra Yüzey Kalitesi

Uzun Dayanma Süresi



KODU	AÇIKLAMA	Paket/Koli	FIYATI
SGS288	115mm	10/200	1.50 \$
SGS289	180mm	10/100	3.20 \$

Turbo Kanalı 115-180-230mm**Elmas Testere**

Isınma ve Aşınmayı

Önleyen Turbo Kanallar

Kuru Kesim

Granit / Seramik / Asfalt / Beton

Taş / Mermer



KODU	AÇIKLAMA	Paket/Koli	FIYATI
SGS2115	115mm	10/200	2.50 \$
SGS2180	180mm	10/50	5.95 \$
SGS2230	230mm	10/40	9.20 \$

Turbo Delikli 115-180-230mm**Elmas Testere**

Isınma ve Aşınmayı

Önleyen Turbo Kanallar

Kuru Kesim

Granit / Seramik / Asfalt / Beton

Taş / Mermer



KODU	AÇIKLAMA	Paket/Koli	FIYATI
SGS2250	115mm	10/200	2.20 \$
SGS2251	180mm	10/50	5.50 \$
SGS2252	230mm	10/40	8.90 \$

Sürekli Elmas Testere

115-180-230mm



Sulu Kesim

Granit / Seramik / Asfalt / Beton

Taş / Mermer



KODU	AÇIKLAMA	Paket/Koli	FIYATI
SGS2260	115mm	10/100	2.55 \$
SGS2261	180mm	10/50	6.25 \$
SGS2262	230mm	10/40	9.30 \$

Soketli Elmas Testere

115-180-230mm



Isınma ve Aşınmayı

Önleyen Turbo Kanallar

Kuru Kesim

Granit / Seramik / Asfalt / Beton

Taş / Mermer



KODU	AÇIKLAMA	Paket/Koli	FIYATI
SGS2255	115mm	10/100	2.50 \$
SGS2256	180mm	10/50	6.40 \$
SGS2257	230mm	10/40	9.70 \$

Turbo Elmas Testere

115-125-180mm

**Ultra İnce** 1.2 x 22.23mm

Çapaksız Hassas Kesim

Sulu ve Kuru Kesim

Kullanım Alanları; Seramik, Granit, Porselen ve Mermer

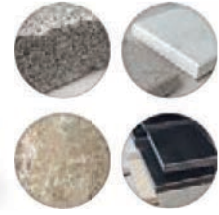
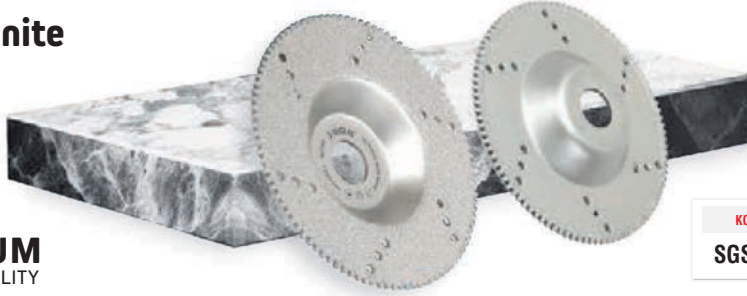

KODU	AÇIKLAMA	Paket/Koli	FİYATI
SGS2265	115mm	10/100	6.00 \$
SGS2264	125mm	10/100	7.00 \$
SGS2266	180mm	10/50	11.00 \$

Elmas Rodajlama DiskiMermer - Granit
Taş - Kuvârs
115mm

KODU	AÇIKLAMA	Paket/Koli	FİYATI
SGS2285	115mm x 22,23mm	5/50	7.50 \$

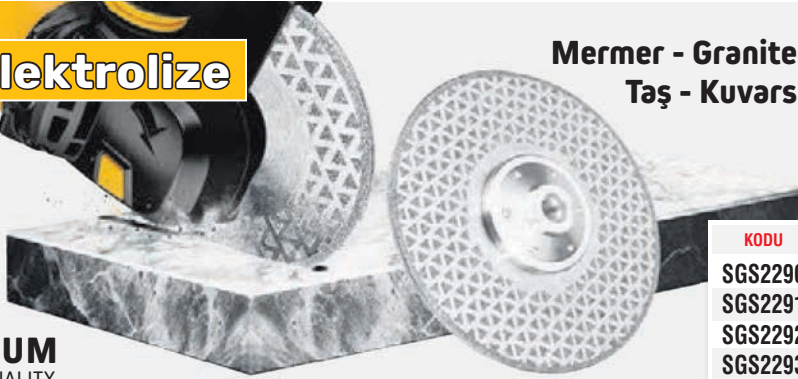
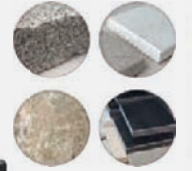
 **PREMIUM**
DIAMOND QUALITY
Flanşlı Elektrolize**Elmas Testere**115-125mm
180-230mmMermer - Granit
Taş - Kuvârs

KODU	AÇIKLAMA	Paket/Koli	FİYATI
SGS2290	115mm - 22,23 - M14	1/50	17.50 \$
SGS2291	125mm - 22,23 - M14	1/50	22.00 \$
SGS2292	180mm - 22,23 - M14	1/25	36.00 \$
SGS2293	230mm - 22,23 - M14	1/20	42.50 \$

 **PREMIUM**
DIAMOND QUALITY
Ahşap İşleme Taşlama Diski

115-125mm

Kavisli

SGS ahşap taşlama diski, yumuşak ve sert ahşap, sunta, laminat ve plastiği şekillendirme, profil oluşturma, oyma, çentik açma, düzleştirme ve taşlama işlemleri için

KODU	AÇIKLAMA	Paket/Koli	FİYATI
SGS2280	115mm x 22,22mm	10/40	5.00 \$
SGS2282	125mm x 22,22mm	10/40	5.75 \$

Ahşap İşleme Taşlama Diski

115-125mm

Düz

SGS ahşap taşlama diski, yumuşak ve sert ahşap, sunta, laminat ve plastiği şekillendirme, profil oluşturma, oyma, çentik açma, düzleştirme ve taşlama işlemleri için

KODU	AÇIKLAMA	Paket/Koli	FİYATI
SGS2281	115mm x 22,22mm	10/40	5.00 \$
SGS2283	125mm x 22,22mm	10/40	5.75 \$

Turbo ElmasPREMIUM
DIAMOND QUALITY**Beton Taşlama Diski**

115-125-180mm

Mermer
Granite
Taş
Kuars

KODU	AÇIKLAMA	Paket/Koli	FİYATI
SGS2310	115mm - 22,23mm	25/50	6.25 \$
SGS2311	125mm - 22,23mm	25/50	8.25 \$
SGS2312	180mm - 22,23mm	10/20	15.85 \$

Çift Sıra ElmasPREMIUM
DIAMOND QUALITY**Beton Taşlama Diski**

115-125-180mm

Mermer
Granite
Taş
Kuars

KODU	AÇIKLAMA	Paket/Koli	FİYATI
SGS2313	115mm - 22,23mm	25/50	6.50 \$
SGS2314	125mm - 22,23mm	25/50	8.50 \$
SGS2315	180mm - 22,23mm	10/20	16.50 \$

Elmas El Zımpara PadiPREMIUM
DIAMOND QUALITY

Keskin kenarları, köşeleri giderir ve pürüzlü yüzeyleri düzeltir. Cam, fayans, seramik, tuğla, taş, ahşap, boya, cam elyaf ve kompozitlerin ıslak veya kuru kullanım ile taşlanma işleminde kullanılır.

KODU	AÇIKLAMA	KOLİ	FİYATI
SGS6245	100 Kum	20	8.50 \$
SGS6246	200 Kum	20	8.50 \$
SGS6247	400 Kum	20	8.50 \$

Elmas Sunta TesterePREMIUM
DIAMOND QUALITYParke, Sunta ve Kompozit
Malzemeler için uygundur.Uzun Ömür için Sertleştirilmiş ve
Güçlendirilmiş Dişler.

KODU	AÇIKLAMA	Paket/Koli	FİYATI
SGS3000	115mm x 24T x 22.23mm	10/100	3.78 \$
SGS3001	115mm x 36T x 22.23mm	10/100	3.99 \$
SGS3002	125mm x 30T x 22.23mm	10/100	4.35 \$
SGS3003	150mm x 24T x 30.00mm	10/100	6.14 \$
SGS3004	160mm x 30T x 30.00mm	10/100	6.93 \$
SGS3005	180mm x 24T x 22.23mm	10/50	8.78 \$
SGS3013	180mm x 24T x 30.00mm	10/50	9.30 \$
SGS3006	180mm x 40T x 22.23mm	10/50	9.30 \$
SGS3014	180mm x 40T x 30.00mm	10/50	9.30 \$
SGS3008	185mm x 40T x 30.00mm	10/50	9.95 \$
SGS3015	190mm x 24T x 30.00mm	10/50	10.16 \$
SGS3009	190mm x 40T x 30.00mm	10/50	10.86 \$
SGS3010	210mm x 40T x 30.00mm	10/50	13.20 \$
SGS3011	230mm x 40T x 30.00mm	10/40	14.75 \$
SGS3012	300mm x 60T x 30.00mm	20	34.15 \$

INOX STAINLESS STEEL

FastCUT

115-125-180-230mm



Sprey Boya

YENİ FORMÜL
Canlı Renkler

FIXED

PAINT

MAXIMUM

INTERIOR - EXTERIOR

PROFESSIONAL - ACRYLIC

SPRAY

Vivid Colors for Metal and
Wood Surfaces

Colors
your
dreams





SGS[®]

Professional Hand Tools

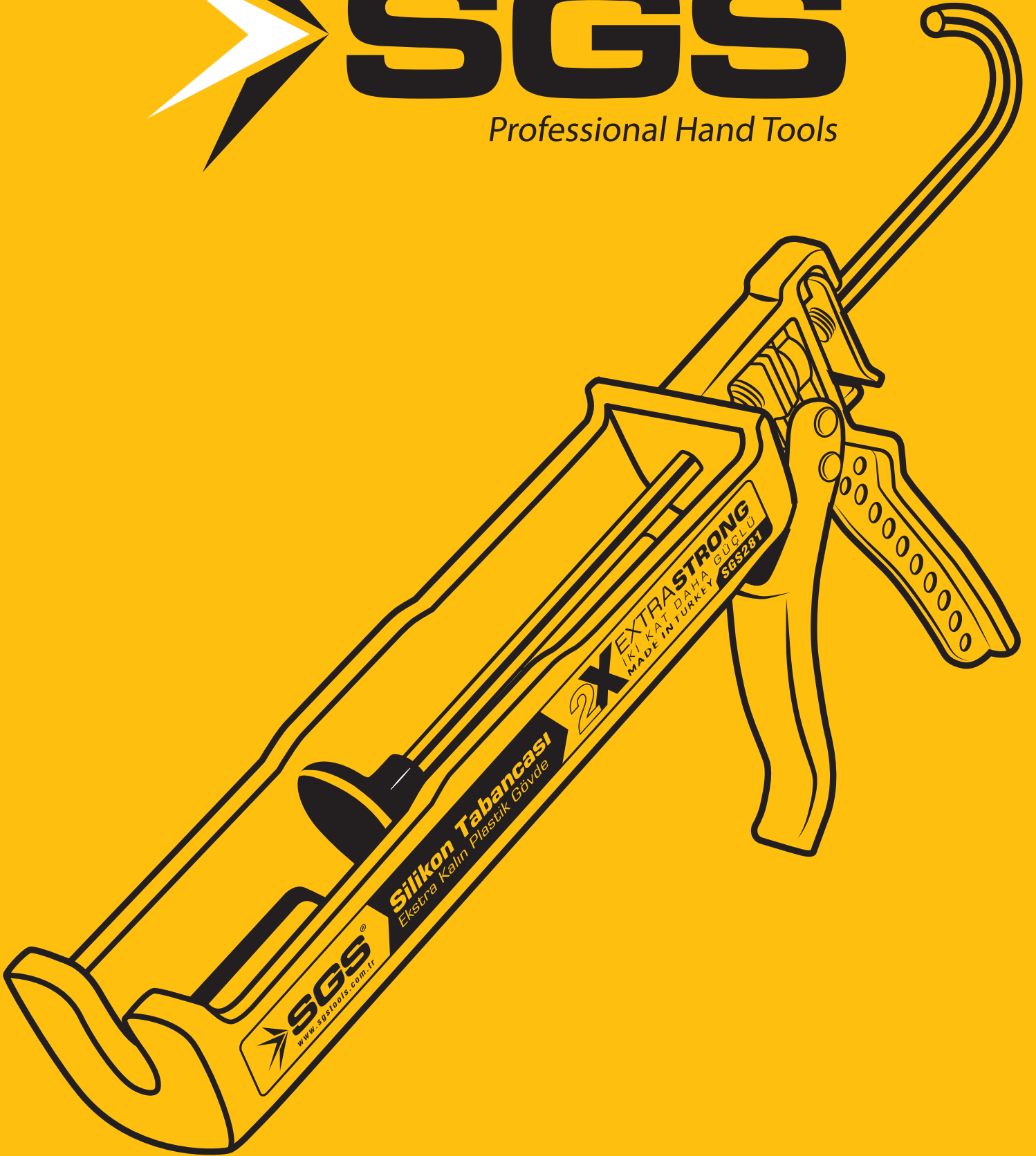



F-450

Silikonize Mastik



- ▶ Hızlı Uygulama
- ▶ Kuvvetli Sızdırmazlık
- ▶ UV Işınlara Dayanıklı



450gr EXTRA STRONG MADE IN TÜRKİYE

KODU	AÇIKLAMA	KOLI	FIYATI
F-450	Beyaz	24	0.90 €



F-500

Silikonize Mastik



- ▶ Hızlı Uygulama
- ▶ Kuvvetli Sızdırmazlık
- ▶ UV Işınlara Dayanıklı



500gr EXTRA STRONG MADE IN TÜRKİYE

KODU	AÇIKLAMA	KOLI	FIYATI
F-500	Beyaz	24	1.00 €



F-280 Silikon



- ▶ Hızlı Uygulama
- ▶ Kuvvetli Sızdırmazlık
- ▶ UV Işınlara Dayanıklı



280gr EXTRA STRONG MADE IN TÜRKİYE

KODU	AÇIKLAMA	KOLI	FIYATI
F-280	Şeffaf	24	1.80 €
F-280B	Beyaz	24	1.80 €
F-280S	Siyah	24	1.80 €



F-310 Silikon



- ▶ Hızlı Uygulama
- ▶ Kuvvetli Sızdırmazlık
- ▶ UV Işınlara Dayanıklı



310gr EXTRA STRONG MADE IN TÜRKİYE

KODU	AÇIKLAMA	KOLI	FIYATI
F-310	Şeffaf	24	2.20 €
F-310B	Beyaz	24	2.20 €
F-310S	Siyah	24	2.20 €



F-310A

Akvaryum Silikon



- ▶ Hızlı Uygulama
- ▶ Kuvvetli Sızdırmazlık
- ▶ UV Işınlara Dayanıklı



310gr EXTRA STRONG MADE IN TÜRKİYE

KODU	AÇIKLAMA	KOLI	FIYATI
F-310A	Akvaryum Silikonu	24	4.00 €



F-310D

Duşakabin Silikon



- ▶ Hızlı Uygulama
- ▶ Kuvvetli Sızdırmazlık
- ▶ UV Işınlara Dayanıklı



310gr EXTRA STRONG MADE IN TÜRKİYE

KODU	AÇIKLAMA	KOLI	FIYATI
F-310D	Şeffaf	24	3.00 €
F-310DB	Beyaz	24	3.00 €



F-320 RTV Silikon

Yüksek Isı Silikonu-Sıvı Conta



- ▶ 250-300°C Yüksek Sıcaklık Dayanımı
- ▶ Kuvvetli Sızdırmazlık



320gr EXTRA STRONG MADE IN TÜRKİYE

KODU	AÇIKLAMA	KOLI	FIYATI
F-320	RTV Silikon	12	3.30 €



F-495 HIGH-TACK

MS Polimer Yapıştırıcı



- ▶ Hızlı Uygulama
- ▶ Kuvvetli Yapıştırma
- ▶ Yüksek İlk Tutunma Gücü



460gr EXTRA STRONG MADE IN TÜRKİYE

KODU	AÇIKLAMA	KOLI	FIYATI
F-495	HIGH-TACK	12	4.40 €



F-50R RTV Tüp Silikon

Yüksek Isı Silikonu-Sıvı Conta



- ▶ 250-300°C Yüksek Sıcaklık Dayanımı
- ▶ Kuvvetli Sızdırmazlık

50gr EXTRA STRONG MADE IN TÜRKİYE

KODU	AÇIKLAMA	Kulu/Kali	FIYATI
F-50R	RTV Silikon	24/192	1.30 €



F-50 Tüp Silikon



- ▶ Hızlı Uygulama
- ▶ Kuvvetli Sızdırmazlık
- ▶ UV Işınlara Dayanıklı

50gr EXTRA STRONG MADE IN TÜRKİYE

KODU	AÇIKLAMA	KOLI	FIYATI
F-50	Şeffaf	24/192	1.10 €
F-50B	Beyaz	24/192	1.10 €



F-1300 Kimyasal Dübel

- ▶ Çift Nozul
- ▶ Yüksek Mukavemet

Hızlı kürleşir ve kurur

Zamandan ve iş gücünden tasarruf sağlar

Düşük sıcaklıklarda bile uygulama yapılabilir

300gr EXTRA STRONG MADE IN TÜRKİYE

Çeşitli inşaat uygulamalarının ankraj işlemleri için özel olarak formüle edilmiş genel amaçlı, polyester bazlı, iki bileşenli, yüksek kaliteli bir üründür. Yaygın bir şekilde yatay ve tiksotropik özelliği sayesinde dikey pozisyonda orta ağırlıktaki yüklemeye işlemleri için kullanılmaktadır.

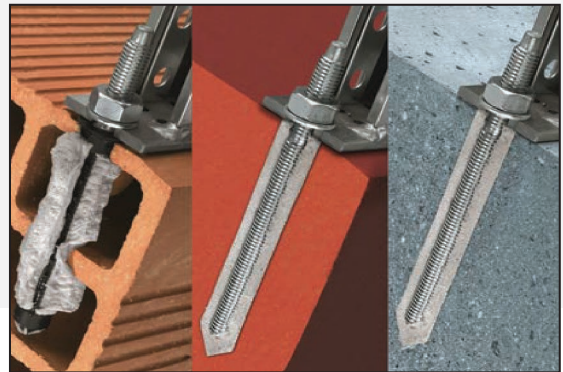

Beton



Doğal Taş



Tuğla



Blok tuğla

KODU	AÇIKLAMA	KOLI	FIYATI
F-1300	Kimyasal Dübel / 300gr	20	5.00 €



F-505

Montaj Yapıştırıcı



- Hızlı Uygulama
- Kuvvetli Yapıştırma
- Yüksek İlk Tutunma Gücü



505gr EXTRA STRONG MADE IN TÜRKİYE

KODU	AÇIKLAMA	KOLİ	FIYATI
F-505	Montaj Yapıştırıcı	24	1.45 €



F-400

Montaj Yapıştırıcı

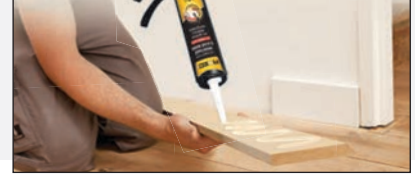

- Hızlı Uygulama
- Kuvvetli Yapıştırma
- Yüksek İlk Tutunma Gücü



400gr EXTRA STRONG MADE IN TÜRKİYE

KODU	AÇIKLAMA	KOLİ	FIYATI
F-400	Montaj Yapıştırıcı	24	4.85 €

Poliüretan

Köpük

- F-300/300gr
- F-600/600gr
- F-850/850gr
- F-850T/850gr
- F-1000T/1000gr



- Ekstra formül
- Çok Amaçlı

KODU	AÇIKLAMA	KOLİ	FIYATI
F-300	300gr	12	2.50 €
F-600	600gr	12	3.60 €
F-850	850gr	12	5.20 €
F-850T	850gr (Tabancalı)	12	5.50 €
F-1000T	1000gr (Tabancalı)70LT	12	6.60 €

Yapıştırıcı Montalama

Poliüretan Köpük

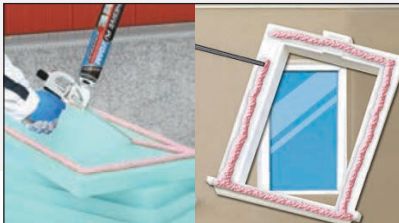

- Ekstra formül
- Çok Amaçlı

850gr EXTRA STRONG MADE IN TÜRKİYE

KODU	AÇIKLAMA	KOLİ	FIYATI
F-850M	850gr	24	6.60 €
F-850MT	850gr(Tabancalı)	24	6.60 €



Poliüretan

Köpük Temizleyici



Poliüretan bazlı kimyasalların temizlenmesinde kullanılır.

420gr EXTRA STRONG MADE IN TÜRKİYE

KODU	AÇIKLAMA	KOLİ	FIYATI
F-420	Pu Temizleyici	12	3.30 €

Köpük tabancasının temizliğinde, poliüretan köpük aerosol valflerinin ve kurumamış köpüğün temizliğinde kullanılır. Köpük tabancasının ömrünü uzatır.



F-510

Poliüretan Mastik



► Ekstra formül ► Çok Amaçlı



280ml EXTRA STRONG MADE IN TÜRKİYE

KODU	AÇIKLAMA	KOLI	FIYATI
F-510B	Beyaz	25	4.20 €
F-510G	Gri	25	4.20 €
F-510S	Siyah	25	4.20 €
F-510K	Kırmızı	25	4.20 €



F-610

Poliüretan Mastik



► Ekstra formül ► Çok Amaçlı



600ml EXTRA STRONG MADE IN TÜRKİYE

KODU	AÇIKLAMA	KOLI	FIYATI
F-610B	Beyaz	12	6.40 €
F-610G	Gri	12	6.40 €
F-610S	Siyah	12	6.40 €
F-610K	Kırmızı	12	6.40 €

Pro-Tight Sıvı Teflon

Boru Sızdırmazlık Elemanı



Her türlü su, yağ, gres ve birçok kimyasalın geçtiği boru dişlileri / Basıncılı kaplar / Hava kompresörleri Hidrolik sistem ve tanklar / Vibrasyona karşı mukavemet gerektiren yerler

Metal-metal ve plastik-metal dişli bağlantılar için uygundur Damlamayan formülasyonu ile kirlenmez Darbelere ve titreşime karşı sızdırmazlık özelliğini korur

Orta Mukavemetli

F-150 50ml EXTRA STRONG MADE IN TÜRKİYE

KODU	AÇIKLAMA	Kutu/Koli	FIYATI
F-150	Sıvı Teflon	10/120	5.00 €

WC-Banyo

Lavabo Açıcı



MADE IN TÜRKİYE

KODU	AÇIKLAMA	KOLI	FIYATI
F-2000	500gr	12	1.10 €
F-2001	1000gr	12	2.00 €
F-2002	2000gr	9	3.00 €

En derin bölgelere kolayca ulaşır



MADE IN TÜRKİYE

Harç - taş - kum - beton gibi inşaat atıklarını kolayca çözer

KODU	AÇIKLAMA	KOLI	FIYATI
F-2010	1000gr	9	2.40 €

En derin bölgelere kolayca ulaşır



Hızlı Yapıştırıcı



MDF, sunta, bütün tahta türleri, kauçuk, deri ve bir çok plastikleri yapıştırmak, onarmak ve sabitlemek için kullanılır.

KODU	AÇIKLAMA	KOLİ	FIYATI
F-1235	200ml/35gr	24	2.00 €
F-245	200ml/45gr	24	2.20 €
F-490	400ml/90gr	12	3.70 €
F-525	500ml/125gr	12	4.50 €

EXTRA STRONG MADE IN TÜRKİYE



Pas Sökücü F-240 / F-440



Paslanmaya Karşı Korur
Her Türlü Pası Çözer



MADE IN TÜRKİYE

KODU	AÇIKLAMA	KOLİ	FIYATI
F-240	200ml	12/120	1.50 €
F-440	400ml	6/60	2.35 €



Speed Derz

Derz Tamir Dolgusu



DOLDURUR
ONARIR YENİLER

380gr EXTRA STRONG MADE IN TÜRKİYE

KODU	AÇIKLAMA	Kutu/Koli	FIYATI
F-380	Speed Derz	12/48	1.80 €



Parlat Temizleme Pastası

Yağ, Küf, Kireç Zor Lekeleri Yok Eder



F-2500
500gr



MADE IN TÜRKİYE

KODU	AÇIKLAMA	Kutu/Koli	FIYATI
F-2500	Parlat / 500gr	12/48	1.00 €

Mum Silikon 1000gr



SGS2300 SGS2301

Ø 7.4 mm	Ø 11.2 mm
300 mm	300 mm



MADE IN TÜRKİYE

KODU	AÇIKLAMA	KOLİ	FIYATI
SGS2300	İnce Mum	10	8.50 €
SGS2301	Kalın Mum	10	8.50 €

Mum Silikon 200gr



SGS2302 SGS2303

Ø 7.4 mm	Ø 11.2 mm
300 mm	300 mm



MADE IN TÜRKİYE

KODU	AÇIKLAMA	KOLİ	FIYATI
SGS2302	İnce Mum	50	1.80 €
SGS2303	Kalın Mum	50	1.80 €

Mum Silikon 1000gr



F-1000 F-1001

Ø 7.4 mm	Ø 11.2 mm
300 mm	300 mm



MADE IN TÜRKİYE

KODU	AÇIKLAMA	KOLİ	FIYATI
F-1000	İnce Mum	25	7.90 €
F-1001	Kalın Mum	25	7.90 €

Sprey Boya

225ml



MADE IN TÜRKİYE

Brüt:180gr

Kutu 12 Adet / Koli 120 Adet

KODU	AÇIKLAMA	FIYATI
F-201	BEYAZ	1.60 €
F-202	SİYAH (PARLAK)	1.60 €
F-203	SİYAH (MAT)	1.60 €
F-204	GRİ	1.60 €
F-205	MAVİ	1.60 €
F-206	SARI	1.60 €
F-207	KIRMIZI	1.60 €
F-208	YEŞİL	1.60 €
F-209	KAHVERENGİ	1.60 €
F-210	KREM	1.60 €
F-211	TURUNCU	1.60 €
F-212	PEMBE	1.60 €
F-213	LACİVERT	1.60 €
F-214	MOR	1.60 €
F-215	METALİK GRİ	1.60 €
F-216	GÜMÜŞ YALDIZ	2.00 €
F-217	ALTIN YALDIZ	2.00 €
F-218	VERNİK PARLAK	1.60 €

Sprey Boya

400ml



MADE IN TÜRKİYE

Brüt:320gr

Kutu 6 Adet / Koli 60 Adet

KODU	AÇIKLAMA	FIYATI
F-221	BEYAZ	2.65 €
F-222	SİYAH (PARLAK)	2.65 €
F-223	SİYAH (MAT)	2.65 €
F-224	GRİ	2.65 €
F-225	MAVİ	2.65 €
F-226	SARI	2.65 €
F-227	KIRMIZI	2.65 €
F-228	YEŞİL	2.65 €
F-229	KAHVERENGİ	2.65 €
F-230	KREM	2.65 €
F-231	TURUNCU	2.65 €
F-232	PEMBE	2.65 €
F-233	LACİVERT	2.65 €
F-234	MOR	2.65 €
F-235	METALİK GRİ	2.65 €
F-236	GÜMÜŞ YALDIZ	3.30 €
F-237	ALTIN YALDIZ	3.30 €
F-238	VERNİK PARLAK	2.65 €

Silikon Tabancası

Plastik Gövde



► Krom Kaplı Mil



MADE IN TÜRKİYE

KODU	AÇIKLAMA	KOLİ	FIYATI
SGS278	Sarı	25	80 ₺
SGS279	Siyah	48	70 ₺

Silikon Tabancası

Ekstra Kalın
Plastik Gövde► Krom
Kaplama Mil

2X EXTRA STRONG
İKİ KAT DAHA GÜÇLÜ



MADE IN TÜRKİYE

KODU	AÇIKLAMA	KOLİ	FIYATI
SGS281	Sarı	12	110 ₺
SGS248	Siyah	12	95 ₺

Epoksi Tabancası

Ekstra Kalın
Plastik Gövde► Krom
Kaplama Mil

2X EXTRA STRONG
İKİ KAT DAHA GÜÇLÜ



MADE IN TÜRKİYE

KODU	AÇIKLAMA	KOLİ	FIYATI
SGS282	Sarı	12	120 ₺
SGS249	Siyah	12	105 ₺

Silikon Tabancası**Alüminyum Gövde**

- 1. Sınıf Elektrostatik Boya
- Krom Kaplamalı Mil



KODU	AÇIKLAMA	KOLİ	FİYATI
SGS272	Silikon Tabancası	12	240 ₺

Epoksi Tabancası**Alüminyum Gövde**

- 1. Sınıf Elektrostatik Boya
- Krom Kaplamalı Mil



KODU	AÇIKLAMA	KOLİ	FİYATI
SGS274	Epoksi Tabancası	12	250 ₺

Sosis Tabancası**Alüminyum Gövde**

- 1. Sınıf Elektrostatik Boya
- Krom Kaplamalı Mil



KODU	AÇIKLAMA	KOLİ	FİYATI
SGS276	Sosis Tabancası/600ml	12	585 ₺

Köpük Tabancası**Krom Kaplı Alüminyum Gövde****Paslanmaz Çelik Namlu**

Bakır Çıkış Memesi

**Köpük Akış Kontrol**

Püskürtme yoğunluğu hassas bir şekilde kontrol etme olanağı sağlar

**Köpük Giriş Adaptörü**

Teflon Kaplı Alüminyum Adaptör Kolay bağlantı %100 sızdırmazlık



KODU	AÇIKLAMA	KOLİ	FİYATI
SGS301	Köpük Tabancası	20	11 \$

Köpük Tabancası**Teflon Kaplı Alüminyum Gövde****Paslanmaz Çelik Namlu**

Bakır Çıkış Memesi

**Köpük Akış Kontrol**

Püskürtme yoğunluğu hassas bir şekilde kontrol etme olanağı sağlar

**Köpük Giriş Adaptörü**

Teflon Kaplı Alüminyum Adaptör Kolay bağlantı %100 sızdırmazlık



KODU	AÇIKLAMA	KOLİ	FİYATI
SGS300	Köpük Tabancası	20	13 \$



SGS[®]

Professional Hand Tools



Koli Bant**Kesme Makinesi****EXTRA
STRONG**

- Bant Gerginlik Ayarı
- Güçlü Metal Gövde
- Bant Genişlik 50 mm

**MADE IN TÜRKİYE**

KODU	AÇIKLAMA	KOLİ	FİYATI
SGS2590	Bant Kesme Makinesi	24	230 ₺

Koli Bant**Kesme Aparatı****EXTRA
STRONG**

- Güçlü Metal Gövde
- Bant Genişlik 50 mm

**MADE IN TÜRKİYE**

KODU	AÇIKLAMA	Kutu/Koli	FİYATI
SGS2591	Bant Kesme Aparatı	12/144	30 ₺

Koli Bandı Şeffaf**40-100 Metre**

Kuvvetli Yapıştırma

**MADE IN TÜRKİYE**

KODU	AÇIKLAMA	Kutu/Koli	FİYATI
SGS2511	Koli Bandı / 40 Metre	6/96	0.50 \$
SGS2515	Koli Bandı / 100 Metre	6/72	1.05 \$

Folyo Bant**Alüminyum****10-20-25 Metre**Kuvvetli Yapıştırma
Nem ve Isıya Dayanıkl**MADE IN TÜRKİYE**

KODU	AÇIKLAMA	Kutu/Koli	FİYATI
SGS2533	44mm/10metre	6/36	0.85 \$
SGS2534	44mm/20metre	6/36	1.50 \$
SGS2532	72mm/25metre	6/24	3.00 \$

Takviyeli Folyo Bant**Alüminyum****48mm - 25 Metre**Kuvvetli Yapıştırma
Nem ve Isıya Dayanıkl**MADE IN TÜRKİYE**

KODU	AÇIKLAMA	Kutu/Koli	FİYATI
SGS2531	48mm/25metre	6/36	2.50 \$

Tamir Bandı



- Kuvvetli Yapıştırma
- Elle Yırtilabilir
- Su Geçirmez



MADE IN TÜRKİYE

48mm x 10 Metre

KODU	AÇIKLAMA	KOLI	FIYATI
SGS1221	GRİ	48	0.85 \$
SGS1222	SİYAH	48	0.85 \$
SGS1223	MAVİ	48	0.85 \$
SGS1224	KIRMIZI	48	0.85 \$
SGS1225	SARI	48	0.85 \$
SGS1226	YEŞİL	48	0.85 \$
SGS1227	BEYAZ	48	0.85 \$

48mm x 40 Metre

SGS1228	GRİ	24	3.70 \$
---------	-----	----	---------

Elektrik

İzolasyon Bandı
10'lu Paket

- 600 Volt ve 80°C Kadar Dayanıklısıdır.
- Sarılm Yaparken Kopmaz

KODU	AÇIKLAMA	KOLI	FIYATI
SGS2950	SİYAH	200	0.38 \$
SGS2951	KIRMIZI	200	0.38 \$
SGS2952	SARI	200	0.38 \$
SGS2953	MAVİ	200	0.38 \$
SGS2954	YEŞİL	200	0.38 \$
SGS2955	BEYAZ	200	0.38 \$
SGS2960	KARIŞIK RENK	200	0.38 \$

Karışık Renk Koli İçeriği (Siyah) 100 Adet (Kırmızı) 20 Adet (Sarı) 20 Adet (Mavi) 20 Adet (Yeşil) 20 Adet (Beyaz) 20 Adet

Kapı Pencere Bandı

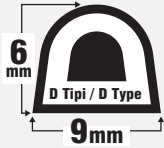
2x3 Metre
D Tipi

WIND PROOF



KODU	AÇIKLAMA	KOLI	FIYATI
F-3005B	BEYAZ	60	1.80 \$
F-3005K	KAHVERENGİ	60	1.80 \$

Kapı Pencere Bandı

2x50 Metre D Tipi



WIND PROOF

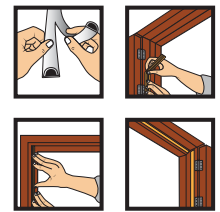
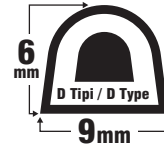

KODU	AÇIKLAMA	KOLI	FIYATI
F-3000	BEYAZ	8	22 \$
F-3001	KAHVERENGİ	8	22 \$

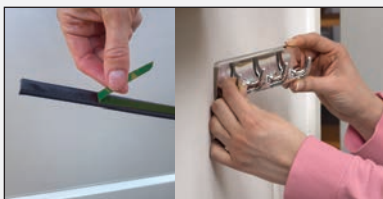
Çift Taraflı 2 Metre
Köpük Bant

MADE IN TÜRKİYE

- Hızlı Uygulama
- Kuvvetli Yapıştırma
- Pe Köpük



KODU	AÇIKLAMA	Kutu/Koli	FIYATI
SGS2543	18mm/2 Metre	24/288	0.31 \$
SGS2544	25mm/2 Metre	24/288	0.36 \$
SGS2545	50mm/2 Metre	12/144	0.72 \$

Çift Taraflı 10 Metre Köpük Bant

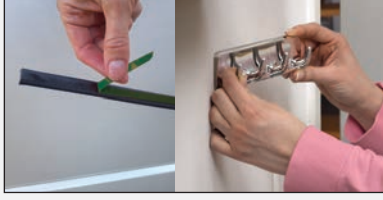

- Hızlı Uygulama
- Kuvvetli Yapıştırma
- Pe Köpük

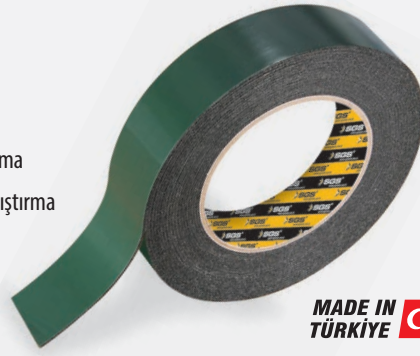

MADE IN TÜRKİYE

10 Metre Çift Taraflı Köpük Bant

KODU	AÇIKLAMA	KOLİ	FİYATI
SGS2535	5mm	210	0.36 \$
SGS2536	10mm	114	0.72 \$
SGS2537	15mm	78	1.10 \$
SGS2538	20mm	60	1.43 \$
SGS2539	25mm	48	1.76 \$
SGS2540	30mm	42	2.15 \$
SGS2541	40mm	30	2.80 \$
SGS2542	50mm	24	3.46 \$

Çift Taraflı 2 Metre Köpük Bant



- Hızlı Uygulama
- Kuvvetli Yapıştırma



MADE IN TÜRKİYE

KODU	AÇIKLAMA	Kutu/Koli	FİYATI
SGS1231	18mm/2 Metre	24/288	0.31 \$
SGS1232	25mm/2 Metre	24/288	0.36 \$
SGS1233	50mm/2 Metre	12/144	0.66 \$

Çift Taraflı 10-20 Metre Köpük Bant



- Hızlı Uygulama
- Kuvvetli Yapıştırma



MADE IN TÜRKİYE

10 Metre Çift Taraflı Köpük Bant

KODU	AÇIKLAMA	KOLİ	FİYATI
SGS1236	18mm/10 Metre	60	1.20 \$
SGS1237	25mm/10 Metre	60	1.65 \$

20 Metre Çift Taraflı Köpük Bant

KODU	AÇIKLAMA	KOLİ	FİYATI
SGS1234	18mm/10 Metre	60	2.42 \$
SGS1235	25mm/10 Metre	80	3.30 \$

Akrilik Silikonize Bant

1-2 Metre



- Hızlı Uygulama
- Kuvvetli Yapıştırma

MADE IN TÜRKİYE



Çivisiz Montaj



1 Metre Akrilik Silikonize Bant

KODU	AÇIKLAMA	KOLİ	FİYATI
SGS2518	18mm/1Metre	84	0.66 \$
SGS2519	24mm /1Metre	72	0.77 \$

2 Metre Akrilik Silikonize Bant

KODU	AÇIKLAMA	KOLİ	FİYATI
SGS2520	18mm/2Metre	84	0.99 \$
SGS2521	24mm /2Metre	72	1.20 \$

Akrilik Silikonize Bant

5 Metre



- Hızlı Uygulama
- Kuvvetli Yapıştırma

MADE IN TÜRKİYE



Çivisiz Montaj



5 Metre Akrilik Silikonize Bant

KODU	AÇIKLAMA	KOLİ	FİYATI
SGS2522	10mm	60	1.32 \$
SGS2523	15mm	40	1.82 \$
SGS2524	20mm	30	2.30 \$
SGS2525	25mm	24	2.85 \$
SGS2526	30mm	20	3.35 \$
SGS2527	40mm	15	4.40 \$
SGS2528	50mm	12	5.45 \$

Maskeleme Bandı**25 Metre**

- İz Bırakmaz
Kolay Sökülür
- Elastik Yapı
İstenen Şekli Alır



Yeni Formül
extra etkili yapışkan

MADE IN TÜRKİYE

25 Metre Maskeleme Bandı

KODU	AÇIKLAMA	Kutu/Koli	FIYATI
SGS2500	18mm	12/96	0.33 €
SGS2501	24mm	12/72	0.44 €
SGS2502	36mm	6/48	0.66 €
SGS2503	48mm	6/36	0.88 €

Çift Taraflı**Halı Kaydırmaz Bant**

- Hızlı Uygulama
- Kuvvetli Yapıştırma



MADE IN TÜRKİYE

1 Bant ile
6m²
Halı

10Metre

KODU	AÇIKLAMA	KOLİ	FIYATI
SGS2275	24mm	48	0.66 \$
SGS2276	48mm	24	1.26 \$

Kaydırmaz Bant

100%
Kaymaz Doku



MADE IN TÜRKİYE



- Kuvvetli Yapıştırma

Kaydırmaz Bant 25mm / 5-15 Metre

KODU	AÇIKLAMA	KOLİ	FIYATI
SGS2270	25mm/5 Metre	48	1.65 \$
SGS2271	25mm/15 Metre	24	4.75 \$

Kaydırmaz Bant 50mm / 5-15 Metre

KODU	AÇIKLAMA	KOLİ	FIYATI
SGS2272	50mm/5 Metre	24	3.30 \$
SGS2273	50mm/15 Metre	12	9.45 \$

Derz Bandı

9x9 / 70gr
Güçlü Fiberglas Yapı

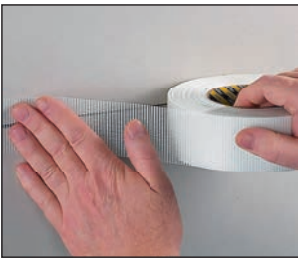

Kendinden Yapışkanlı

Pürüzsüz Yüzey

Alçı levhalarının birleşim yerlerinde çatlakları önlemek için kullanılır.

**Tam Metraj**

KODU	AÇIKLAMA	KOLİ	FIYATI
SGS2560	50mm x 45 Metre	48	1.50 \$
SGS2561	50mm x 90 Metre	24	2.90 \$
SGS2562	100mm x 90 Metre	12	5.75 \$

Kapı Altı İzolasyon Bandı**35mm x 3Metre**

Rüzgâr, Ses, Toz ve Haşerât Geçirmez
Kendinden Yapışkanlı
Kapı ve Pencere Kullanımına Uygundur.



YÜKSEK YAPIŞMA GÜCÜ

KODU	AÇIKLAMA	KOLİ	FIYATI
SGS1243	Kapı Altı İzolasyon Bandı	24	2.00 \$

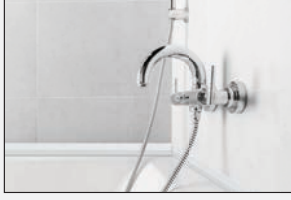
Sızdırmazlık Bandı**38mm x 3.35 Metre****Nem, Yağ ve Küfe Karşı Dayanıklı**Duşakabin - Küvet
Lavabo - Mutfak Tezgahı

KODU	AÇIKLAMA	KOLİ	FIYATI
SGS1240	Sızdırmazlık Bandı	50	4.50 \$

Teflon Bant**EXTRA****12 MM**
10 Metre
0.25g/cm³
0.075mm

İçme Suyu Hatları İçin Uygundur.

Sıvı ve Hava Hatlarındaki Tüm Dişli Bağlantılarda Kullanılır.

100% SIZDIRMAZLIK
Yüksek Yoğunluk

MADE IN TÜRKİYE

0.25g/cm³ - 12mm
0.075mm x 10 Metre

KODU	AÇIKLAMA	Kutu/Koli	FIYATI
SGS1200	Teflon Bant Extra	250/1000	0.20 \$

Teflon Bant**PROFESSIONAL****12 MM**
10 Metre
0.35g/cm³
0.075mm

İçme Suyu Hatları İçin Uygundur.

Sıvı ve Hava Hatlarındaki Tüm Dişli Bağlantılarda Kullanılır.

100% SIZDIRMAZLIK
Yüksek Yoğunluk

MADE IN TÜRKİYE

0.35g/cm³ - 12mm
0.075mm x 10 Metre

KODU	AÇIKLAMA	Kutu/Koli	FIYATI
SGS1201	Teflon Bant Profesioal	250/1000	0.24 \$

Teflon Bant**JUMBO****19 MM**
30 Metre
0.35g/cm³
0.075mm

İçme Suyu Hatları İçin Uygundur.

Sıvı ve Hava Hatlarındaki Tüm Dişli Bağlantılarda Kullanılır.

100% SIZDIRMAZLIK
Yüksek Yoğunluk

MADE IN TÜRKİYE

0.35g/cm³ - 19mm
0.075mm x 30 Metre

KODU	AÇIKLAMA	Kutu/Koli	FIYATI
SGS1202	Teflon Bant Jumbo	25/250	0.85 \$

Gaz Teflon Bant**PROFESSIONAL****12 MM**
8 Metre
1.00g/cm³
0.1mm

Benzin, Petrol Yağları, Gaz ve Doğal Gaz Borularının Bağlantı ve Montajında Kullanılır.



MADE IN TÜRKİYE

100% SIZDIRMAZLIK
Yüksek Yoğunluk1.00g/cm³ - 12mm
0.1mm x 8 Metre

KODU	AÇIKLAMA	Kutu/Koli	FIYATI
SGS1203	Teflon Bant Profesioal	250/1000	0.45 \$



SGS[®]

Professional Hand Tools

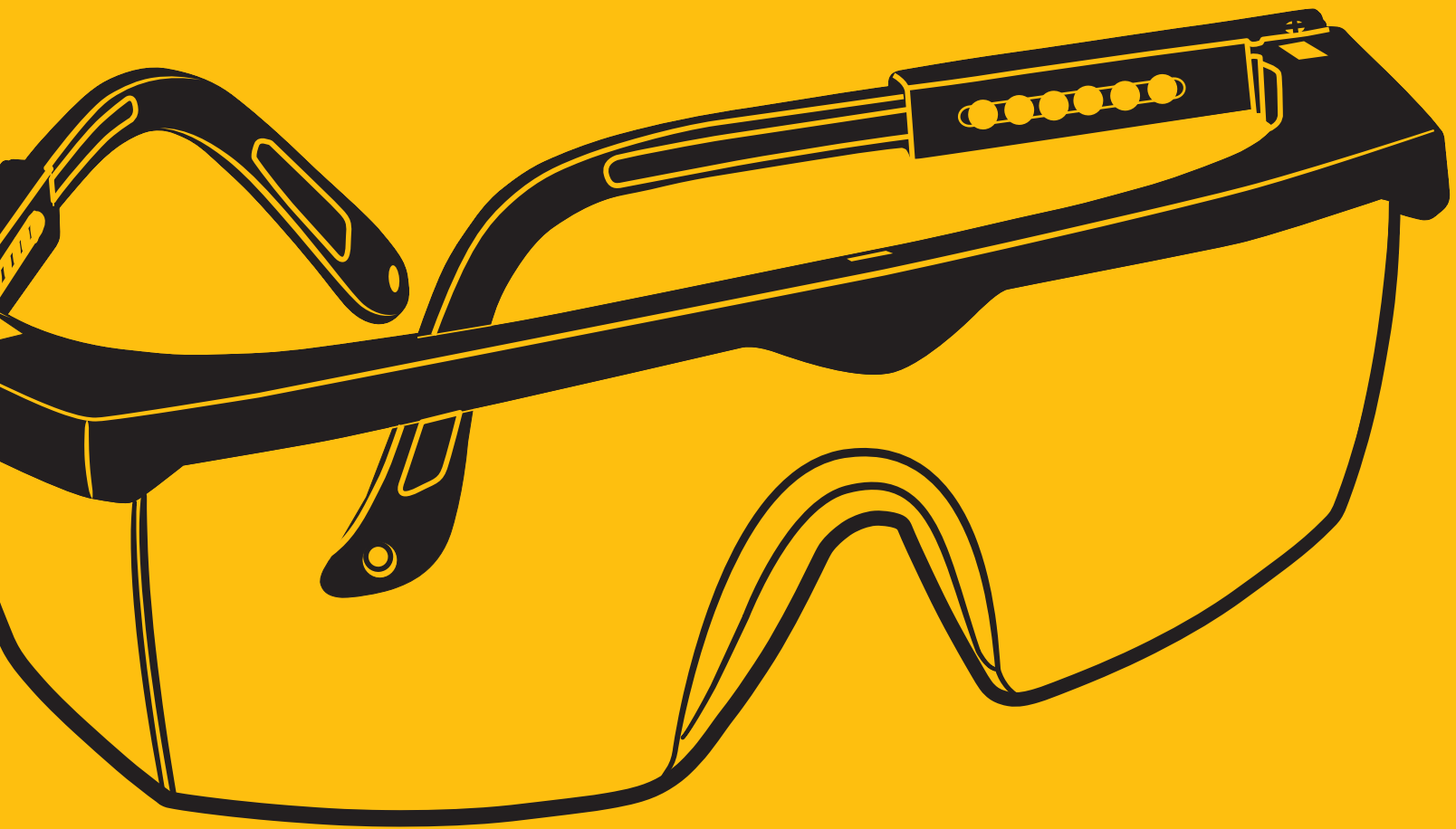

Koruyucu Gözlük Classic

High-Impact Polycarbonete Lens



MADE IN TÜRKİYE

Yüksek Etkili
Polikarbon Lens
Darbe Dayanlı
UV Filtreli



KODU	AÇIKLAMA	Kutu/Koli	FİYATI
SGS303	ŞEFFAF	12/120	30 ₺
SGS308	SARI	12/120	30 ₺
SGS304	FÜME	12/120	30 ₺
SGS305	ŞİYAH	12/120	30 ₺

Koruyucu Gözlük Focus

High-Impact Polycarbonete Lens

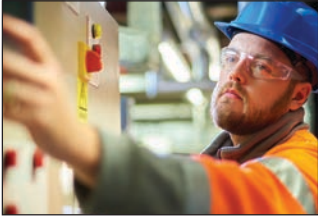

MADE IN TÜRKİYE

Yüksek Etkili
Polikarbon Lens
Darbe Dayanlı
UV Filtreli



KODU	AÇIKLAMA	Kutu/Koli	FİYATI
SGS760	ŞEFFAF	12/120	35 ₺
SGS761	FÜME	12/120	35 ₺
SGS762	ŞİYAH	12/120	35 ₺

Koruyucu Gözlük Cover

High-Impact Polycarbonete Lens



MADE IN TÜRKİYE

Yüksek Etkili
Polikarbon Lens
Darbe Dayanlı
UV Filtreli



- Gözlük Üstü Kullanım
- Hava Ventilileri
- Hava UV Filtreli

KODU	AÇIKLAMA	Kutu/Koli	FİYATI
SGS768	COVER	12/120	30 ₺

Koruyucu Gözlük Optimum

High-Impact Polycarbonete Lens



MADE IN TÜRKİYE

Yüksek Etkili
Polikarbon Lens
Darbe Dayanlı
UV Filtreli



- Gözlük Üstü Kullanım
- Hava Ventilileri
- Hava UV Filtreli

KODU	AÇIKLAMA	Kutu/Koli	FİYATI
SGS770	OPTIMUM	6/60	65 ₺

Kulak Tıkacı

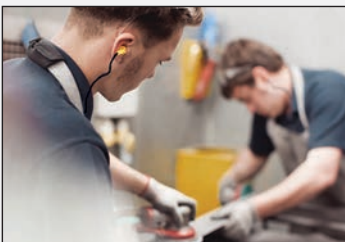

EN 352:2 - 2002



MADE IN TÜRKİYE

- 4 Kademeli, Ultra Yumuşak Polimer Dizayn
- Antialerjik Yıkabilir Malzeme
- Tek Ölçü, Her Kulak Yapısına Uygun
- Dahili Tutacak Yeri ile Hijyenik Çalışma



KODU	AÇIKLAMA	Kutu/Koli	FİYATI
SGS701	Kulak Tıkacı	50/300	20 ₺

Speed Eldiven Sarı**Nitril Kaplı Örme Eldiven****MADE IN TÜRKİYE** 

- ▶ Aşınmaya ve Yarılmaya Karşı Dirençli
- ▶ Örme Elastik Bilek
- ▶ Nitril Kaplama

10
BOY/SIZE

Otomotiv, tarım, yükleme ve montaj gibi hafif sanayi işleri için uygundur.

KODU	AÇIKLAMA	KOLI	FİYATI
SGS7710	Speed 10	250	0.70 \$

Poly Eldiven Kırmızı**Nitril Kaplı Örme Eldiven****MADE IN TÜRKİYE** 

- ▶ Aşınmaya ve Yarılmaya Karşı Dirençli
- ▶ Örme Elastik Bilek
- ▶ Nitril Kaplama

10
BOY/SIZE

Otomotiv, tarım, yükleme ve montaj gibi hafif sanayi işleri için uygundur.

KODU	AÇIKLAMA	KOLI	FİYATI
SGS7610	Poly 10	240	0.77 \$

Zebra Eldiven Mavi**Nitril Kaplı Örme Eldiven****MADE IN TÜRKİYE** 

- ▶ Aşınmaya ve Yarılmaya Karşı Dirençli
- ▶ Örme Elastik Bilek
- ▶ Nitril Kaplama

10
BOY/SIZE

Otomotiv, tarım, yükleme ve montaj gibi hafif sanayi işleri için uygundur.

KODU	AÇIKLAMA	KOLI	FİYATI
SGS7120	Zebra Mavi	240	0.90 \$

Zebra Eldiven Kırmızı**Nitril Kaplı Örme Eldiven****MADE IN TÜRKİYE** 

- ▶ Aşınmaya ve Yarılmaya Karşı Dirençli
- ▶ Örme Elastik Bilek
- ▶ Nitril Kaplama

10
BOY/SIZE

Otomotiv, tarım, yükleme ve montaj gibi hafif sanayi işleri için uygundur.

KODU	AÇIKLAMA	KOLI	FİYATI
SGS7110	Zebra Kırmızı	240	0.90 \$

Zebra Eldiven Sarı**Nitril Kaplı Örme Eldiven****MADE IN TÜRKİYE** 

- ▶ Aşınmaya ve Yarılmaya Karşı Dirençli
- ▶ Örme Elastik Bilek
- ▶ Nitril Kaplama

10
BOY/SIZE

Otomotiv, tarım, yükleme ve montaj gibi hafif sanayi işleri için uygundur.

KODU	AÇIKLAMA	KOLI	FİYATI
SGS7130	Zebra Sarı	240	0.90 \$

Zebra Eldiven Siyah**Nitril Kaplı Örme Eldiven****MADE IN TÜRKİYE** 

- ▶ Aşınmaya ve Yarılmaya Karşı Dirençli
- ▶ Örme Elastik Bilek
- ▶ Nitril Kaplama

10
BOY/SIZE

Otomotiv, tarım, yükleme ve montaj gibi hafif sanayi işleri için uygundur.

KODU	AÇIKLAMA	KOLI	FİYATI
SGS7140	Zebra Siyah	240	0.90 \$

Koruyucu Baret**Automatic - Manuel**Havalandırmalı
UV DirençliKöpük
Ter BandıMADE IN
TÜRKİYE**Koruyucu Baret Manuel Ayarlı**

KODU	AÇIKLAMA	KOLİ	FİYATI
SGS1110-BLW	Baret-Beyaz	30	90 ₺
SGS1110-BLY	Baret-Sarı	30	90 ₺

Koruyucu Baret Automatic Ayarlı

KODU	AÇIKLAMA	KOLİ	FİYATI
SGS1110-ALW	Baret-Beyaz	30	100 ₺
SGS1110-ALY	Baret-Sarı	30	100 ₺

Yüz Maskesi**Ventilli FFP2****3****Katlı Koruma**Dikişsiz olup ultrasonik
yapıştırma ile üretilmiştir.Cilt Dostu Katman
Malzemesi**FFP2****Face Mask**Solunum Kolaylığı
Sağlayan Hava ValfiPaslanmaz
Burun Teli

EN149:2001

KODU	AÇIKLAMA	Kutu/Koli	FİYATI
SGS307	Toz Maskesi	25/500	10 ₺

İş Güvenlik Ayakkabısı**Deri Çelik Burunlu**MADE IN
TÜRKİYE

KODU	AÇIKLAMA	KOLİ	FİYATI
SGS1136	36	20	600 ₺
SGS1137	37	20	600 ₺
SGS1138	38	20	600 ₺
SGS1139	39	20	600 ₺
SGS1140	40	20	600 ₺
SGS1141	41	20	600 ₺
SGS1142	42	20	600 ₺
SGS1143	43	20	600 ₺
SGS1144	44	20	600 ₺
SGS1145	45	20	600 ₺

İş Güvenlik Ayakkabısı**Süet Çelik Burunlu**MADE IN
TÜRKİYE

KODU	AÇIKLAMA	KOLİ	FİYATI
SGS1846	36	20	600 ₺
SGS1847	37	20	600 ₺
SGS1838	38	20	600 ₺
SGS1839	39	20	600 ₺
SGS1840	40	20	600 ₺
SGS1841	41	20	600 ₺
SGS1842	42	20	600 ₺
SGS1843	43	20	600 ₺
SGS1844	44	20	600 ₺
SGS1845	45	20	600 ₺
SGS1848	46	20	600 ₺

İş Güvenlik Botu**Deri Çelik Burunlu**MADE IN
TÜRKİYEMADE IN
TÜRKİYE

KODU	AÇIKLAMA	KOLİ	FİYATI
SGS1740	40	20	700 ₺
SGS1741	41	20	700 ₺
SGS1742	42	20	700 ₺
SGS1743	43	20	700 ₺
SGS1744	44	20	700 ₺
SGS1745	45	20	700 ₺
SGS1746	46	20	700 ₺



Asma Kilit Gri Boyalı



3 Anahtarlı
Keys

- Korozyona Karşı Piriç Silindir
- Paslanmaz Yaylar
- Krom Kaplama Çelik Kanca
- Plastik Conta



**EXTRA
STRONG**



Asma Kilit Gri Boyalı

KODU	AÇIKLAMA	Kutu/Koli	FİYATI
SGS1320	20mm	12/600	0.50 \$
SGS1321	25mm	6/600	0.55 \$
SGS1322	32mm	6/240	1.00 \$
SGS1323	38mm	6/240	1.25 \$
SGS1324	50mm	6/120	1.85 \$
SGS1325	63mm	6/60	2.65 \$

Asma Kilit Gri Boyalı Uzun Kanca



3 Anahtarlı
Keys

- Korozyona Karşı Piriç Silindir
- Paslanmaz Yaylar
- Krom Kaplama Çelik Kanca
- Plastik Conta



**EXTRA
STRONG**



Asma Kilit Gri Boyalı Uzun Kanca

KODU	AÇIKLAMA	Kutu/Koli	FİYATI
SGS1330	32mm	6/240	1.10 \$
SGS1331	38mm	6/240	1.35 \$
SGS1332	50mm	6/120	2.00 \$
SGS1333	63mm	6/60	2.85 \$

Asma Kilit Sarı Boyalı



3 Anahtarlı
Keys

- Korozyona Karşı Piriç Silindir
- Paslanmaz Yaylar
- Krom Kaplama Çelik Kanca
- Plastik Conta



**EXTRA
STRONG**



Asma Kilit Sarı Boyalı

KODU	AÇIKLAMA	Kutu/Koli	FİYATI
SGS1340	20mm	12/600	0.50 \$
SGS1341	25mm	6/600	0.55 \$
SGS1342	32mm	6/240	1.00 \$
SGS1343	38mm	6/240	1.25 \$
SGS1344	50mm	6/120	1.85 \$
SGS1345	63mm	6/60	2.65 \$

Asma Kilit Sarı Boyalı Uzun Kanca



3 Anahtarlı
Keys

- Korozyona Karşı Piriç Silindir
- Paslanmaz Yaylar
- Krom Kaplama Çelik Kanca
- Plastik Conta



**EXTRA
STRONG**



Asma Kilit Sarı Boyalı Uzun Kanca

KODU	AÇIKLAMA	Kutu/Koli	FİYATI
SGS1350	32mm	6/240	1.10 \$
SGS1351	38mm	6/240	1.35 \$
SGS1352	50mm	6/120	2.00 \$
SGS1353	63mm	6/60	2.85 \$

Asma Kilit Kayar Milli Sarı Kaplama



3 Anahtarlı
Keys

- Korozyona Karşı Piriç Silindir
- Darbeye Dayanıklı Çelik Gövde
- Krom Kaplama Çelik Kanca



**EXTRA
STRONG**



Asma Kilit Kayar Milli Sarı Kaplama

KODU	AÇIKLAMA	Kutu/Koli	FİYATI
SGS1360	70mm	6/48	5.50 \$
SGS1361	80mm	6/48	6.00 \$
SGS1362	90mm	6/36	6.50 \$

Asma Kilit**Kayar Milli
Saten Kaplama**

- Korozyona Karşı Pirinç Silindir
- Krom Kaplama Çelik Kanca
- Darbeye Dayanıklı Çelik Gövde

**3** Anahtarlı
Keys**EXTRA
STRONG****2YIL
GARANTİ**
ÜRETİM
MÜHÜRÜ**Asma Kilit Kayar Milli
Saten Kaplama**

KODU	AÇIKLAMA	Kutu/Koli	FİYATI
SGS1365	70mm	6/48	5.50 \$
SGS1366	80mm	6/48	6.00 \$
SGS1367	90mm	6/36	6.50 \$

Asma Kilit**Kayar Milli
Çelik Koruma**

- Korozyona Karşı Pirinç Silindir
- Krom Kaplama Çelik Kanca
- Darbeye Dayanıklı Çelik Korumalı Gövde

**3** Anahtarlı
Keys**EXTRA
STRONG****2YIL
GARANTİ**
ÜRETİM
MÜHÜRÜ**Asma Kilit Kayar Milli
Çelik Koruma**

KODU	AÇIKLAMA	Kutu/Koli	FİYATI
SGS1370	70mm	6/48	7.00 \$
SGS1371	80mm	6/48	7.75 \$
SGS1372	90mm	6/24	8.50 \$

Asma Kilit**Mini Şifreli****32**
MM**3 Şifreli
Kombinasyon**Eşyalarınızı dolabınızı
ve bavulunuzu
güvende
tutabilirsiniz.
Korozyona
Dayanıklı Gövde**LONG LIFE
HIGH QUALITY****MULTIPURPOSE**
Çok Amaçlı Kullanım

KODU	AÇIKLAMA	Kutu/Koli	FİYATI
SGS1335	Mini Şifreli Asma Kilit	6/240	2.40 \$

Posta Kutusu**Plastik Gövde**

- Kırılmaz Plastik Gövde
- Kızaklı Geçme Sistemi
- Krom Mandallı Kilit 2 Anahtarlı

**EXTRA
STRONG****2YIL
GARANTİ**
ÜRETİM
MÜHÜRÜ**MADE IN
TÜRKİYE**

KODU	AÇIKLAMA	KOLİ	FİYATI
SGS332	Posta Kutusu / Plastik	20	200 ₺

Posta Kutusu**Metal Gövde**

- 1.00mm Kalınlığında Sacdan Üretilmiş Gövde
- Korozyonu Önleyen 1. Sınıf Elektrostatik Toz Boya
- Krom Mandallı Kilit 2 Anahtarlı

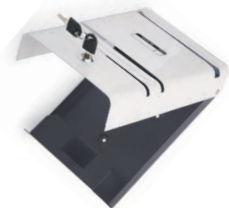
**2YIL
GARANTİ**
ÜRETİM
MÜHÜRÜ**MADE IN
TÜRKİYE** **EXTRA
STRONG**

KODU	AÇIKLAMA	KOLİ	FİYATI
SGS333	Posta Kutusu / Metal	20	210 ₺



PANZER

PPRC Boru Kaynak
Makine Seti
1500 W



MADE IN
TURKEY

- ▶ 750 + 750 Paslanmaz Çift Rezistans
- ▶ Sıcaklık Aralığı 50-300 °C
- ▶ Polisajlı Alüminyum Ütü
- ▶ Frekans 50-60 Hz

Set İçeriği : Metal Çanta
Kaynak Makinesi - Metal Ayak
Alyen Anahtar - Pafta Seti (20-25-32-40mm)





SGS[®]

Professional Hand Tools

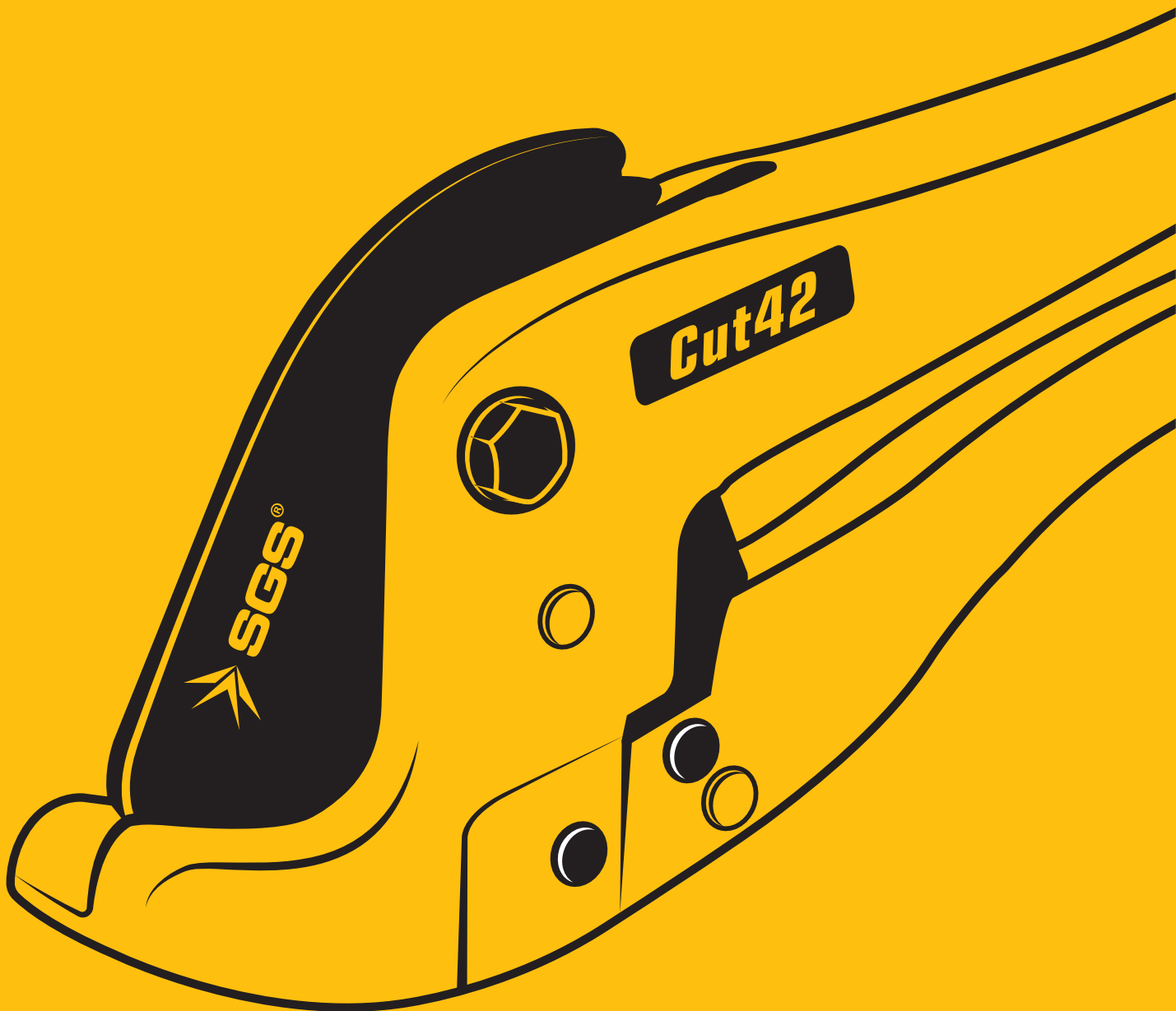

Panzer 1500W**Boru Kaynak
Makine Seti**750 + 750 Watt
Paslanmaz Çift Rezistans

220~230 Volt

- Sıcaklık Aralığı 50-300 °C
- Polisajlı Alüminyum Ütü
- Frekans 50-60 Hz

EXTRA
STRONGMADE IN
TÜRKİYE

KODU	AÇIKLAMA	KOLİ	FIYATI
SGS348	Panzer/1500 Watt	6	2000 ₺

Set İçeriği : Metal Çanta
Kaynak Makinası-Metal Ayak
Alyen Anahtar
Pafta Seti:
(20-25-32-40mm)**Delux 1200W****Boru Kaynak
Makine Seti**600 + 600 Watt
Paslanmaz Çift Rezistans

220~230 Volt

- Sıcaklık Aralığı 50-300 °C
- Polisajlı Alüminyum Ütü
- Frekans 50-60 Hz

EXTRA
STRONGMADE IN
TÜRKİYE

KODU	AÇIKLAMA	KOLİ	FIYATI
SGS345	Delux/1200 Watt	6	2000 ₺

Set İçeriği : Metal Çanta
Kaynak Makinası - Metal Ayak
Alyen Anahtar
Pafta Seti:
(20-25-32-40mm)**jaws 42****42mm
Boru Makası
Alüminyum Gövde**

- Isıl İşlem Uygulanmış ve Bilenmiş Yüksek Karbon Çeliği Bıçak
- Kolay Kesim Sağlayan Gövde Dizaynı

PVC, PEX, Plastik Hortum, Lastik Hortumlar,
Naylon, PV, ABS, PE, PS
Boru kesmek için tasarlanmıştır.EXTRA
STRONGSTRONG
CUTTER BLADE

KODU	AÇIKLAMA	Kolu / Koli	FIYATI
SGS1012	Jaws 42/42mm Boru Makası	10/50	8.50 \$

Gold 42 Automatic

Otomatik Bıçak Açma Sistemi

**42mm
Boru Makası
Alüminyum Gövde**Isıl İşlem Uygulanmış ve Bilenmiş
Yüksek Karbon Çeliği BıçakEXTRA
STRONGPVC, PEX, Plastik Hortum, Lastik Hortumlar, Naylon, PV, ABS, PE, PS
Boru kesmek için tasarlanmıştır.

KODU	AÇIKLAMA	Kutu/Koli	FIYATI
SGS1011	Gold 42/42mm Boru Makası	10/50	9.00 \$

Cut 42 Automatic

Otomatik Bıçak Açma Sistemi

**42mm
Boru Makası
Metal Gövde**Isıl İşlem Uygulanmış ve Bilenmiş
Yüksek Karbon Çeliği BıçakEXTRA
STRONGPVC, PEX, Plastik Hortum, Lastik Hortumlar, Naylon, PV, ABS, PE, PS
Boru kesmek için tasarlanmıştır.

KODU	AÇIKLAMA	Kutu/Koli	FIYATI
SGS1017	Cut 42/42mm Boru Makası	10/50	6.50 \$

Class 42**42mm
Boru Makası
Alüminyum Gövde**Isıl İşlem Uygulanmış ve Bilenmiş
Yüksek Karbon Çeliği BıçakEXTRA
STRONGPVC, PEX, Plastik Hortum, Lastik Hortumlar, Naylon, PV, ABS, PE, PS
Boru kesmek için tasarlanmıştır.

KODU	AÇIKLAMA	Kutu/Koli	FIYATI
SGS1010	Cut 42/42mm Boru Makası	10/50	7.00 \$

Pro 63**63mm
Boru Makası
Alüminyum Gövde**Isıl İşlem Uygulanmış ve Bilenmiş
Yüksek Karbon Çeliği BıçakEXTRA
STRONGPVC, PEX, Plastik Hortum, Lastik Hortumlar, Naylon, PV, ABS, PE, PS
Boru kesmek için tasarlanmıştır.

KODU	AÇIKLAMA	KOLI	FIYATI
SGS1016	Pro 63/63mm Boru Makası	10	33 \$

PROSTEP

Professional Metal Ladder



Çok Amaçlı Üst Başlık

Multi-Purpose Cap



Plastik Mentеше

Plastic Connection Ear



Özel Tasarım

Geniş Basamak

Large Step



Yüksek Güvenlikli

Geniş Tabla

Large Top Table



Özel Tasarım

Taşıma Kolu

Handle For Carrying



**MAX
150kg**

**EXTRA
STRONG**



**MADE IN
TURKEY**

PROSTEP



SGS[®]

Professional Hand Tools



Makaralı Güçlü Plastik Gövde**Uzatma Kablo**

- ▶ 4'lü Entegre Priz
- ▶ Makara Sistemi
- ▶ Darbelere Dayanıklı Gövde

EXTRA
STRONG

KODU	AÇIKLAMA	KOLİ	FIYAT
SGS2130	3x1,5/20metre	2	715 ₺
SGS2131	3x1,5/35metre	2	940 ₺
SGS2132	3x1,5/50metre	2	1.180 ₺
SGS2133	3x2,5/20metre	2	850 ₺
SGS2134	3x2,5/30metre	2	1.065 ₺
SGS2135	3x2,5/40metre	2	1.275 ₺
SGS2136	3x2,5/50metre	2	1.470 ₺
SGS2120	Boş Makara	2	365 ₺

Makaralı Güçlü Metal Gövde**Uzatma Kablo**

- ▶ 4'lü Entegre Priz
- ▶ Makara Sistemi
- ▶ Darbelere Dayanıklı Gövde

EXTRA
STRONG

KODU	AÇIKLAMA	KOLİ	FIYAT
SGS2110	3x2,5/20metre	2	1.386 ₺
SGS2111	3x2,5/30metre	2	1.610 ₺
SGS2112	3x2,5/40metre	2	1.834 ₺
SGS2113	3x2,5/50metre	2	2.058 ₺
SGS2114	Boş Makara	2	784 ₺

Makaralı Güçlü Plastik Gövde**Uzatma Kablo**

5 Metre 3x1mm

EXTRA
STRONGTTR Kablo
BAKIR SARIM

KODU	AÇIKLAMA	KOLİ	FIYATI
SGS2190	3x1mm / 5 Metre	12	430 ₺

Uzatma Kablo**Kauçuk Priz**

Topraklı Monofaze Entegre Priz

EXTRA
STRONG

- ▶ Darbelere Dayanıklı Gövde
- ▶ Koruyucu Kapak

MADE IN
TÜRKİYE

KODU	AÇIKLAMA	KOLİ	FIYAT
SGS2206	3x1,5/10metre	15	325 ₺
SGS2208	3x1,5/20metre	8	490 ₺
SGS2210	3x1,5/30metre	6	665 ₺
SGS2212	3x1,5/40metre	4	830 ₺
SGS2214	3x1,5/50metre	2	995 ₺
SGS2216	3x2,5/10metre	15	390 ₺
SGS2218	3x2,5/20metre	8	620 ₺
SGS2220	3x2,5/30metre	6	860 ₺
SGS2222	3x2,5/40metre	4	1.090 ₺
SGS2224	3x2,5/50metre	2	1.320 ₺

Uzatma Kablo**3'lü Kauçuk Grup Priz**

Topraklı Monofaze Entegre Priz

- ▶ Darbelere Dayanıklı Gövde
- ▶ Koruyucu Kapaklar

MADE IN
TÜRKİYE

KODU	AÇIKLAMA	KOLİ	FIYAT
SGS3512	3x2,5/5metre	15	305 ₺
SGS3513	3x2,5/10metre	10	430 ₺
SGS3514	3x2,5/20metre	6	665 ₺
SGS3515	3x2,5/30metre	5	885 ₺
SGS3516	3x2,5/40metre	4	1.135 ₺
SGS3517	3x2,5/50metre	2	1.365 ₺

Grup Priz / Fiş**Kauçuk Grup Priz
Kauçuk Fiş**

Topraklı Monofaze Entegre Priz

- ▶ Darbelere Dayanıklı Gövde
- ▶ Koruyucu Kapaklar

MADE IN
TÜRKİYEEXTRA
STRONG**Erkek - Dişi Kauçuk Fiş**

KODU	AÇIKLAMA	KOLİ	FIYATI
SGS3502	Erkek Kauçuk Fiş	50	30 ₺
SGS3503	Dişi Kauçuk Fiş	40	40 ₺

Kauçuk Grup Priz

KODU	AÇIKLAMA	KOLİ	FIYATI
SGS3501	2'li Grup Priz	20	90 ₺
SGS3500	3'lü Grup Priz	20	100 ₺

Home Step Metal Merdiven



Çok Amaçlı
Üst Başlık

Çelik Mentеше
Sistemi



Plastik
Üst Tabla

D Profil
Basamak



MAX
150kg

SGS1162	SGS1163	SGS1164	SGS1165	SGS1166	SGS1167
2+1 Basamak / Steps	3+1 Basamak / Steps	4+1 Basamak / Steps	5+1 Basamak / Steps	6+1 Basamak / Steps	7+1 Basamak / Steps

2YIL
GARANTİ
ÜRETİM
KURULUMU

EXTRA
STRONG



MADE IN
TÜRKİYE

KODU	AÇIKLAMA	KOLI	FİYAT
SGS1162	2+1 Basamak	1	21 \$
SGS1163	3+1 Basamak	1	26 \$
SGS1164	4+1 Basamak	1	30 \$
SGS1165	5+1 Basamak	1	34 \$
SGS1166	6+1 Basamak	1	40 \$
SGS1167	7+1 Basamak	1	46 \$

Double Step Metal Merdiven



Plastik
Menteşe

Kaymayı Önleyen
Plastik Ayak



Ekstra Koruma
Güvenlik Kayışı

D Profil
Basamak



MAX
150kg

SGS1182	SGS1183	SGS1184	SGS1185	SGS1186	SGS1187
2+2 Basamak / Steps	3+3 Basamak / Steps	4+4 Basamak / Steps	5+5 Basamak / Steps	6+6 Basamak / Steps	7+7 Basamak / Steps

2YIL
GARANTİ
ÜRETİM
KURULUMU

EXTRA
STRONG



MADE IN
TÜRKİYE

KODU	AÇIKLAMA	KOLI	FİYAT
SGS1182	2+2 Basamak	1	17 \$
SGS1183	3+3 Basamak	1	24 \$
SGS1184	4+4 Basamak	1	31 \$
SGS1185	5+5 Basamak	1	39 \$
SGS1186	6+6 Basamak	1	49 \$
SGS1187	7+7 Basamak	1	57 \$

Pro Step Metal Merdiven



Çok Amaçlı
Üst Başlık

Özel Tasarım
Taşıma Kolu



Yüksek Güvenlikli
Geniş Tabla

Özel Tasarım
Geniş Basamak



MAX
150kg

SGS1172	SGS1173	SGS1174	SGS1175	SGS1176	SGS1177	SGS1178	SGS1179
2+1 Basamak / Steps	3+1 Basamak / Steps	4+1 Basamak / Steps	5+1 Basamak / Steps	6+1 Basamak / Steps	7+1 Basamak / Steps	8+1 Basamak / Steps	9+1 Basamak / Steps



Plastik
Menteşe

2YIL
GARANTİ
ÜRETİM
KURULUMU

EXTRA
STRONG



MADE IN
TÜRKİYE

KODU	AÇIKLAMA	KOLI	FİYAT
SGS1172	2+1 Basamak	1	32 \$
SGS1173	3+1 Basamak	1	37 \$
SGS1174	4+1 Basamak	1	43 \$
SGS1175	5+1 Basamak	1	49 \$
SGS1176	6+1 Basamak	1	54 \$
SGS1177	7+1 Basamak	1	61 \$
SGS1178	8+1 Basamak	1	68 \$
SGS1179	9+1 Basamak	1	74 \$

Cırt KelepçeMADE IN TÜRKİYE **Beyaz** 

Kendinden Kilitlemeli Sistem

Kolay ve Hızlı Montaj

1. Sınıf Malzeme

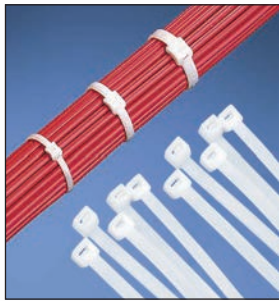
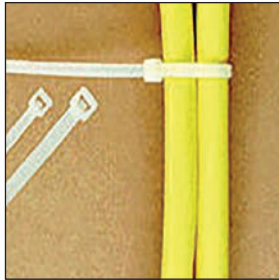
**EXTRA
STRONG****6.6
NYLON****85°
-40°****Cırt Kelepçe 2.5mm**

KODU	AÇIKLAMA	KOLİ	FIYATI
SGS4500	2,5 x 100mm	500	0.31 €
SGS4501	2,5 x 150mm	400	0.53 €
SGS4502	2,5 x 200mm	250	0.70 €

Cırt Kelepçe 3.6mm

KODU	AÇIKLAMA	KOLİ	FIYATI
SGS4506	3,6 x 150mm	200	0.76 €
SGS4507	3,6 x 200mm	150	1.04 €
SGS4508	3,6 x 250mm	150	1.40 €
SGS4509	3,6 x 300mm	150	1.56 €
SGS4510	3,6 x 370mm	150	2.16 €

Cırt Kelepçe 4.8mm

KODU	AÇIKLAMA	KOLİ	FIYATI
SGS4515	4,8 x 200mm	150	1.53 €
SGS4516	4,8 x 250mm	150	1.86 €
SGS4517	4,8 x 300mm	125	2.16 €
SGS4518	4,8 x 350mm	100	2.73 €
SGS4519	4,8 x 380mm	100	2.86 €
SGS4520	4,8 x 450mm	90	3.53 €
SGS4521	4,8 x 500mm	70	4.05 €

Cırt Kelepçe 8.0mm

KODU	AÇIKLAMA	KOLİ	FIYATI
SGS4523	8,0 x 200mm	70	4.32 €
SGS4524	8,0 x 300mm	60	4.82 €
SGS4525	8,0 x 380mm	50	5.05 €
SGS4526	8,0 x 450mm	45	6.25 €
SGS4531	8,0 x 550mm	40	8.18 €
SGS4527	8,0 x 650mm	25	12.60 €
SGS4528	8,0 x 800mm	25	15.30 €

Cırt Kelepçe 9.0mm

KODU	AÇIKLAMA	KOLİ	FIYATI
SGS4529	9,0 x 1000mm	10	21.28 €
SGS4530	9,0 x 1200mm	10	26.53 €

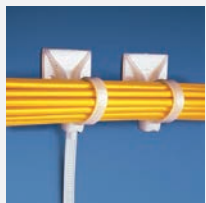
Yapışkanlı Kroşe**6.6
NYLON****85°
-40°**MADE IN TÜRKİYE 

• Alttaki koruyucu kağıdı kaldırılarak ahşap, formika, yağlı boya, metal, plastik, cam gibi yüzeylere kolayca, anında yapışır.
Yapıştırma yüzeyi kuru, tozsuz ve yağsız olmalıdır.

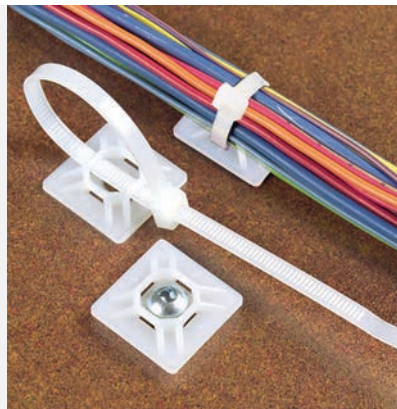

- Kuvvetli Yapıştırma
- Kolay ve Hızlı Montaj
- 1. Sınıf Malzeme



KODU	AÇIKLAMA	KOLİ	100 ADET/FİYATI
SGS4540	19x19mm	170	2.75 €
SGS4541	28x28mm	90	4.40 €

Cırt KelepçeMADE IN
TÜRKİYE**Siyah**

Kendinden Kilitlemeli Sistem

Kolay ve Hızlı Montaj

1. Sınıf Malzeme

**EXTRA
STRONG****6.6
NYLON****85°
-40°****Cırt Kelepçe 2.5mm**

KODU	AÇIKLAMA	KOLI	FIYATI
SGS4600	2,5 x 100mm	500	0.31 €
SGS4601	2,5 x 150mm	400	0.53 €
SGS4602	2,5 x 200mm	250	0.70 €

Cırt Kelepçe 3.6mm

KODU	AÇIKLAMA	KOLI	FIYATI
SGS4606	3,6 x 150mm	200	0.76 €
SGS4607	3,6 x 200mm	150	1.04 €
SGS4608	3,6 x 250mm	150	1.40 €
SGS4609	3,6 x 300mm	150	1.56 €
SGS4610	3,6 x 370mm	150	2.16 €

Cırt Kelepçe 4.8mm

KODU	AÇIKLAMA	KOLI	FIYATI
SGS4615	4,8 x 200mm	150	1.53 €
SGS4616	4,8 x 250mm	150	1.86 €
SGS4617	4,8 x 300mm	125	2.16 €
SGS4618	4,8 x 350mm	100	2.73 €
SGS4619	4,8 x 380mm	100	2.86 €
SGS4620	4,8 x 450mm	90	3.53 €
SGS4621	4,8 x 500mm	70	4.05 €

Cırt Kelepçe 8.0mm

KODU	AÇIKLAMA	KOLI	FIYATI
SGS4623	8,0 x 200mm	70	4.32 €
SGS4624	8,0 x 300mm	60	4.82 €
SGS4625	8,0 x 380mm	50	5.05 €
SGS4626	8,0 x 450mm	45	6.25 €
SGS4631	8,0 x 550mm	40	8.18 €
SGS4627	8,0 x 650mm	25	12.60 €
SGS4628	8,0 x 800mm	25	15.30 €

Cırt Kelepçe 9.0mm

KODU	AÇIKLAMA	KOLI	FIYATI
SGS4629	9,0 x 1000mm	10	21.28 €
SGS4630	9,0 x 1200mm	10	26.53 €

Oto Kar Paleti

- ▶ Kendinden Kilitlemeli Sistem
- ▶ Paletli Dış Tasarımı ile Güçlü Yol Tutuşu Sağlar
- ▶ Tüm Otomobil Lastikleri İçin Uygundur

**EXTRA
STRONG**MADE IN
TÜRKİYE**Hızlı ve Pratik Montaj**

KODU	AÇIKLAMA	Paket / Koli	FIYATI
SGS4700	Oto Kar Paleti Sarı	10/50	110 ₺

Kaynak Pensesi**300 Amper**

- ▶ Korumalı Yaylı Çeneler
- ▶ Güvenli Yalıtım Kompakt Yapı
- ▶ 45°- 90°- 180° Açılarda Çalışma
- ▶ Bakalit Gövde
- ▶ Yüksek İletkenlik

2YIL
GARANTİ
ÜRETİM
SARILMASI**EXTRA
STRONG**

KODU	AÇIKLAMA	KOLI	FİYATI
SGS315	300 Amper	50	3.00 \$

Kaynak Pensesi**400 Amper**

- ▶ Korumalı Yaylı Çeneler
- ▶ Güvenli Yalıtım Kompakt Yapı
- ▶ 45°- 90°- 180° Açılarda Çalışma
- ▶ Bakalit Gövde
- ▶ Yüksek İletkenlik

2YIL
GARANTİ
ÜRETİM
SARILMASI**EXTRA
STRONG**

KODU	AÇIKLAMA	KOLI	FİYATI
SGS316	400 Amper	50	5.70 \$

Kaynak Pensesi**500 Amper**

- ▶ Korumalı Yaylı Çeneler
- ▶ Güvenli Yalıtım Kompakt Yapı
- ▶ 45°- 90°- 180° Açılarda Çalışma
- ▶ Bakalit Gövde
- ▶ Yüksek İletkenlik

2YIL
GARANTİ
ÜRETİM
SARILMASI**EXTRA
STRONG**

KODU	AÇIKLAMA	KOLI	FİYATI
SGS317	500 Amper	50	5.80 \$

Kaynak Pensesi**600 Amper**

- ▶ Korumalı Yaylı Çeneler
- ▶ Güvenli Yalıtım Kompakt Yapı
- ▶ 45°- 90°- 180° Açılarda Çalışma
- ▶ Bakalit Gövde
- ▶ Yüksek İletkenlik

2YIL
GARANTİ
ÜRETİM
SARILMASI**EXTRA
STRONG**

KODU	AÇIKLAMA	KOLI	FİYATI
SGS318	600 Amper	25	6.00 \$

Şase Pensesi**300-500 Amper**

- ▶ Yaylı Çeneler
- ▶ Somunlu Kablo Bağlantısı
- ▶ Pozitif Topraklama
- ▶ Krom Kaplama
- ▶ Yüksek İletkenlik

2YIL
GARANTİ
ÜRETİM
SARILMASI**EXTRA
STRONG**

KODU	AÇIKLAMA	KOLI	FİYATI
SGS319	300 Amper	50	3.50 \$
SGS320	500 Amper	50	5.30 \$

Kaynak Maske Camı**110x80mm**

Ultraviyole ve Kızılötesi Işınlara Karşı Koruma

DIN 777
SHADE No:10
TH 10 XTW 1

3mm
KALINLIK

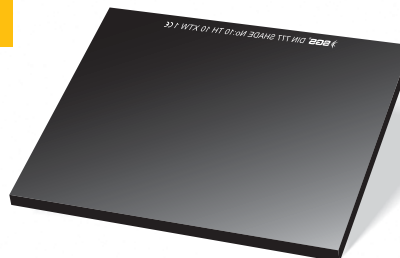

CE



KODU	AÇIKLAMA	Paket / Koli	FİYATI
SGS306	Maske Camı	50/400	0.36 \$



Professional Hand Tools



Maket Bıçağı Seti

**72'li
Metal
Ürün
Standı**



KODU	AÇIKLAMA	KOLİ	FIYATI
SGS1790	72'li Maket Bıçağı Set	1	6.756 ₺

Maket Bıçağı**Plastik Gövde**

Yüksek Basınca Dayanımlı
ABS Plastik Gövde



MADE IN TÜRKİYE



KODU	AÇIKLAMA	Kutu/Koli	FIYATI
SGS1783	Maket Bıçağı / Plastik Gövde	24/192	78 ₺

**2YIL
GARANTİ**
ÜRETİM
MÜHÜRÜ

**Maket Bıçağı****Plastik Gövde**

Yüksek Basınca Dayanımlı
ABS Plastik Gövde



MADE IN TÜRKİYE



KODU	AÇIKLAMA	Kutu/Koli	FIYATI
SGS1787	Maket Bıçağı / Plastik Gövde	24/192	78 ₺

**2YIL
GARANTİ**
ÜRETİM
MÜHÜRÜ

**Maket Bıçağı****Plastik Gövde**

Yüksek Basınca Dayanımlı
Çift Komponentli
ABS Plastik Gövde



MADE IN TÜRKİYE



KODU	AÇIKLAMA	Kutu/Koli	FIYATI
SGS1780	Maket Bıçağı / Plastik Gövde	24/192	78 ₺

**2YIL
GARANTİ**
ÜRETİM
MÜHÜRÜ

**Maket Bıçağı****Plastik Gövde**

Yüksek Basınca Dayanımlı
ABS Plastik Gövde



MADE IN TÜRKİYE



KODU	AÇIKLAMA	Kutu/Koli	FIYATI
SGS1781	Maket Bıçağı / Plastik Gövde	24/192	78 ₺

**2YIL
GARANTİ**
ÜRETİM
MÜHÜRÜ



Maket Bıçağı**Alüminyum Gövde**

Yüksek Basınca Dayanıkl
Alüminyum Gövde

**MADE IN TÜRKİYE**

KODU	AÇIKLAMA	Kutu/Koli	FIYATI
SGS1785	Maket Bıçağı/Alüminyum Gövde	24/192	104 ₺

Maket Bıçağı**Alüminyum Gövde**

Yüksek Basınca Dayanıkl
Alüminyum Gövde

**MADE IN TÜRKİYE**

KODU	AÇIKLAMA	Kutu/Koli	FIYATI
SGS1784	Maket Bıçağı/Alüminyum Gövde	24/192	134 ₺

Maket Bıçağı**Alüminyum Gövde**

Yüksek Basınca Dayanıkl
Alüminyum Gövde

**MADE IN TÜRKİYE**

KODU	AÇIKLAMA	Kutu/Koli	FIYATI
SGS160	Maket Bıçağı/Alüminyum Gövde	24/240	60 ₺

Maket Bıçağı**Alüminyum Dar Gövde**

Yüksek Basınca Dayanıkl
Alüminyum Gövde

**MADE IN TÜRKİYE**

KODU	AÇIKLAMA	Kutu/Koli	FIYATI
SGS1782	Maket Bıçağı/Alüminyum Gövde	36/432	104 ₺

Kazıma Bıçağı**Plastik Gövde****3'lü Yedek Bıçak 60mm**

Yüksek Basınca Dayanıkl
Plastik Gövde

**3'lü Yedek Bıçak****MADE IN TÜRKİYE**

KODU	AÇIKLAMA	Kutu/Koli	FIYATI
SGS181	Kazıma Bıçağı / Plastik Gövde	12/120	30 ₺

Kazıma Bıçağı**Plastik Gövde 100mm**

Pratik Bıçak Kilitleme Sistemi

Koruyucu Kapak

Yüksek Basınca Dayanıklı
ABS Plastik Gövde

MADE IN TÜRKİYE



2YIL GARANTİ



KODU	AÇIKLAMA	Kutu/Koli	FIYATI
SGS1786	Kazıma Bıçağı / Plastik Gövde	12/192	110 ₺

Maket Bıçağı Yedeği**18x0.40mm**

Yüksek Kalite Karbonlu

Takım Çeliği



2YIL GARANTİ



MADE IN TÜRKİYE



KODU	AÇIKLAMA	Kutu/Koli	FIYATI
SGS171	Maket Bıçağı Yedek Uç / 18x0.40mm	100/4000	7.00 \$

Maket Bıçağı Yedeği**18x0.50mm**

Yüksek Kalite Karbonlu

Takım Çeliği



2YIL GARANTİ



MADE IN TÜRKİYE

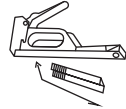

KODU	AÇIKLAMA	Kutu/Koli	FIYATI
SGS164	Maket Bıçağı Yedek Uç / 18x0.50mm	100/4000	8.50 \$

Zimba TabancasıBüyük
Zimba YuvasıAltın
Yükleme KızakEkstra konfor için
ergonomik tutuş

2YIL GARANTİ

**Extra Strong**

KODU	AÇIKLAMA	Kutu/Koli	FIYATI
SGS1042	Zimba Tabancası	6/36	16 \$

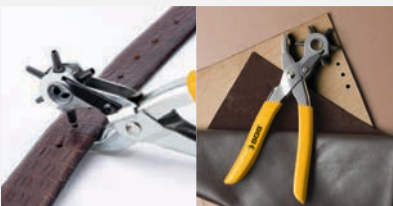
Kemer Delme**Zimbasi 9"/225mm****6 Farklı Ölçü Ayarlanabilir
Delik Delme Başlığı**

2.0-2.5-3.0-3.5-4.0-4.5mm

► Yüksek Basınca
Dayanıklı Metal Gövde► Emniyet Kilitli
Güvenli Taşıma

2YIL GARANTİ



KODU	AÇIKLAMA	KOLI	FIYATI
SGS1080	Kemer Delme Zimbasi	60	5 \$

Çelik Şerit Metre



- ▶ 3mx16mm
- ▶ 5mx19mm
- ▶ 5mx25mm
- ▶ 10mx25mm



- ▶ Darbeye Dayanıklı ABS Kasa
- ▶ Yüksek Çözünürlüklü Özel Baskı Tekniği
- ▶ Azami Uzunlukta Dik Durma
- ▶ Kemer Klipsi ve Taşıma Askısı

KODU	AÇIKLAMA	Paket / Koli	FİYAT
SGS2000	3m x 16mm	12/120	1.80 \$
SGS2001	5m x 19mm	12/120	2.50 \$
SGS2002	5m x 25mm	12/96	3.00 \$
SGS2003	10m x 25mm	12/60	6.35 \$

Çelik Şerit Metre



- ▶ 3mx16mm
- ▶ 5mx19mm
- ▶ 5mx25mm
- ▶ 10mx25mm



- ▶ Darbeye Dayanıklı ABS Kasa
- ▶ Yüksek Çözünürlüklü Özel Baskı Tekniği
- ▶ Azami Uzunlukta Dik Durma
- ▶ Kemer Klipsi ve Taşıma Askısı

KODU	AÇIKLAMA	Paket / Koli	FİYAT
SGS2060	3m x 16mm	12/120	1.90 \$
SGS2061	5m x 19mm	12/120	2.70 \$
SGS2062	5m x 25mm	12/96	3.20 \$
SGS2063	10m x 25mm	12/60	6.85 \$

Çelik Şerit Metre



Double Stop

Çift Stoplu



- ▶ 3mx16mm
- ▶ 5mx19mm
- ▶ 5mx25mm
- ▶ 10mx25mm



- ▶ Darbeye Dayanıklı ABS Kasa
- ▶ Yüksek Çözünürlüklü Özel Baskı Tekniği
- ▶ Azami Uzunlukta Dik Durma
- ▶ Kemer Klipsi ve Taşıma Askısı

KODU	AÇIKLAMA	Paket / Koli	FİYAT
SGS2080	3m x 16mm	12/120	2.25 \$
SGS2081	5m x 19mm	12/120	3.10 \$
SGS2082	5m x 25mm	12/96	3.60 \$
SGS2083	10m x 25mm	12/60	7.00 \$

Marangoz Gönye



250-300mm

350-400mm

Dayanıklı Serigraf Baskı

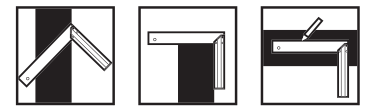

90° - 45° Açılarda Milimetrik Çalışma

KODU	AÇIKLAMA	Paket / Koli	FİYAT
SGS1690	250mm	20/120	1.45 \$
SGS1691	300mm	20/120	1.60 \$
SGS1692	350mm	20/120	1.75 \$
SGS1693	400mm	20/120	1.95 \$

Alüminyum Gönye



Dayanıklı Serigraf Baskı

Ekstra Fonksiyon Su Terazisi

90° - 45° Açılarda Milimetrik Çalışma



250-300-350mm
400-500-600mm

KODU	AÇIKLAMA	Paket / Koli	FİYAT
SGS1700	250mm	6/60	4.25 \$
SGS1701	300mm	6/60	4.50 \$
SGS1702	350mm	6/60	4.75 \$
SGS1703	400mm	6/60	5.25 \$
SGS1704	500mm	6/60	6.00 \$
SGS1705	600mm	6/60	6.60 \$

Mini Su Terazisi**Mıknatıslı 23cm**

- ▶ Yüksek Hassasiyet
- ▶ Darbe Emici Kapaklar



KODU	AÇIKLAMA	Paket/Koli	FİYAT
SGS1709	Mini Su Terazisi	6/120	1.80 \$

Alüminyum Su Terazisi

- ▶ Yüksek Hassasiyet
- ▶ Basınca Dayanıklı Alüminyum Gövde
- ▶ 1. Sınıf Elektrostatik Boya
- ▶ Darbe Emici Kapaklar

*Maximum Stability*

KODU	AÇIKLAMA	Paket/Koli	FİYAT
SGS1710	40cm	10/60	4.25 \$
SGS1711	50cm	10/60	4.50 \$
SGS1712	60cm	10/60	5.00 \$
SGS1713	80cm	10/60	6.20 \$
SGS1714	100cm	10/60	7.50 \$

Alüminyum Su Terazisi**Mıknatıslı***Spirit Level Magnetic*

- ▶ Yüksek Hassasiyet
- ▶ Basınca Dayanıklı Alüminyum Gövde
- ▶ 1. Sınıf Eloksal Kaplama
- ▶ Darbe Emici Kapaklar

*Maximum Stability*

KODU	AÇIKLAMA	Paket/Koli	FİYAT
SGS1716	40cm	10/40	7.50 \$
SGS1717	50cm	10/40	8.00 \$
SGS1718	60cm	10/40	9.00 \$
SGS1719	70cm	10/40	10.00 \$
SGS1720	80cm	10/20	11.00 \$
SGS1721	100cm	10/20	12.50 \$

Boyalı Çelik Keser**EXTRA STRONG**

- ▶ Isıl İşlem Uygulanmış Polijanlı Keser



- ▶ Korozyona Karşı Elektrostatik Toz Boya
- ▶ Gürgen Ağaç Ahşap Sap

**MADE IN TÜRKİYE**

KODU	AÇIKLAMA	Kutu/Koli	FİYAT
SGS192	Boyalı Çelik Keser	6/24	150 ₺

Boyalı Çelik Keser

- ▶ Isıl İşlem Uygulanmış Polijanlı Keser
- ▶ Korozyona Karşı Elektrostatik Toz Boya
- ▶ Gürgen Ağaç Ahşap Sap

**EXTRA STRONG****MADE IN TÜRKİYE**

KODU	AÇIKLAMA	KOLİ	FİYAT
SGS187	Boyalı Çelik Keser	25	180 ₺

Keski- Murç

Plastik Korumalı



► Tavlınmış Yüksek Çelik Kalitesi

► Kullanım Konforu Sağlayan Plastik Sap



MADE IN TÜRKİYE

KODU	AÇIKLAMA	KOLİ	FİYAT
SGS241	Korumalı Keski	12	3.20 \$
SGS242	Korumalı Murç	12	3.20 \$

Metal Yağdanlık

Spiral Uç

300cc
500cc

► Uzun Ömür
Metal Gövde

► Elokrostatik
Toz Boya

► Her Türlü Erişilmesi Zor Yerlere Kolay Uygulama.



MADE IN TÜRKİYE

KODU	AÇIKLAMA	KOLİ	FİYAT
SGS749	Metal Uç / 300cc	12	135₺
SGS750	Spiral Uç / 300cc	12	135₺
SGS748	Metal Uç / 500cc	12	140₺

Spiralli Huni

Çelik Süzgeçli



Ø160mm
1,2LT



► Esnek Spiral Boru



► Çelik Süzgeç

► Her Türlü Erişilmesi Zor Yerlere Kolay Uygulama.

► Yağlara ve Asitlere Dayanıklı Özel Plastik Malzeme



MADE IN TÜRKİYE

KODU	AÇIKLAMA	KOLİ	FİYAT
SGS2400	160mm	30	80 ₺

Lavabo Açma Sustası



► Ø6mm Spiral Esnek Yay



MADE IN TÜRKİYE

KODU	AÇIKLAMA	KOLİ	FİYAT
SGS971	3 Metre	24	90 ₺
SGS972	5 Metre	24	120 ₺
SGS973	8 Metre	24	150 ₺

Titreşim

Önleyici Ayak



Titreşimi
Emer
KAYMAYI
ÖNLER



UNIVERSAL

Tüm Makineler
ile Uyumlu

MADE IN TÜRKİYE



KAYDIRMAZ
VANTUZLU



KODU	AÇIKLAMA	KOLİ	FİYATI
SGS6220	Titreşim Önleyici Ayak / 4'lü Set	48	70 ₺

Allen Anahtar Seti Cr-V**9 Parça**

KODU	AÇIKLAMA	Kutu/Koli	FİYAT
SGS1060	Allen Seti / 9 Parça	6/36	5.00 \$

Tetikli Şalümo

Alev Boyunu Ayarlayan Tetik'li Musluk Sistemi

Ø 57mm Başlık

- Krom Kaplama Gövde
- 8mm Gaz Hortumuna Uyumlu Rekor

Her türlü tavlama, ahşap ve boya yakma, kurutma, yumuşak lehim, gümüş ve altın kaynağı işlerinde kullanılmak üzere üretilmiştir.

**MAXIMUM PERFORMANCE****MADE IN TÜRKİYE**

KODU	AÇIKLAMA	KOLİ	FİYAT
SGS-T13	13cm	20	575₺
SGS-T25	25cm	20	610₺
SGS-T33	33cm	20	675₺
SGS-T45	45cm	20	750₺
SGS-T75	75cm	20	780₺

Vanalı Şalümo

Alev Boyunu Ayarlayan Vanalı Musluk Sistemi

Ø 57mm Başlık

- Krom Kaplama Gövde
- 8mm Gaz Hortumuna Uyumlu Rekor

Her türlü tavlama, ahşap ve boya yakma, kurutma, yumuşak lehim, gümüş ve altın kaynağı işlerinde kullanılmak üzere üretilmiştir.

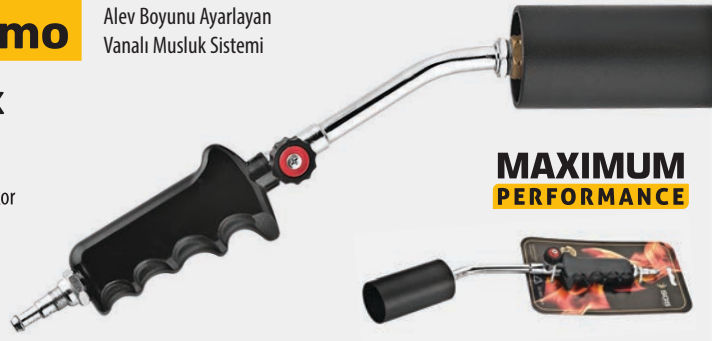
**MAXIMUM PERFORMANCE****MADE IN TÜRKİYE**

KODU	AÇIKLAMA	KOLİ	FİYAT
SGS-V13	13cm	20	470₺
SGS-V25	25cm	20	520₺
SGS-V33	33cm	20	550₺
SGS-V45	45cm	20	580₺
SGS-V75	75cm	20	620₺

Vanalı Şalümo

Alev Boyunu Ayarlayan Vanalı Musluk Sistemi

**Vakumlu Set
Ø 57mm Başlık**

- Krom Kaplama Gövde
- 8mm Gaz Hortumuna Uyumlu Rekor

Her türlü tavlama, ahşap ve boya yakma, kurutma, yumuşak lehim, gümüş ve altın kaynağı işlerinde kullanılmak üzere üretilmiştir.

MAXIMUM PERFORMANCE**MADE IN TÜRKİYE**

Set İçeriği : 57mm Başlık
13cm Vanalı Şalümo / Prinç Musluk
8mm LPG Hortumu / Hortum Kelepçesi (2 Adet)

KODU	AÇIKLAMA	KOLİ	FİYAT
SGS805	Şalümo Vanalı Set	20	650 ₺

Pürmüz Vakumlu Set**Ø 32mm Başlık**

- Çinko Kaplama Gövde
- 8mm Gaz Hortumuna Uyumlu Rekor

Her türlü tavlama, ahşap ve boya yakma, kurutma, yumuşak lehim, gümüş ve altın kaynağı işlerinde kullanılmak üzere üretilmiştir.

MAXIMUM PERFORMANCE**MADE IN TÜRKİYE**

Set İçeriği : 32mm Başlıklı Pürmüz
Prinç Musluk / 8mm LPG Hortumu
Hortum Kelepçesi (2 Adet)

KODU	AÇIKLAMA	KOLİ	FİYAT
SGS801	Pürmüz Vakumlu Set	20	290 ₺



Professional Hand Tools

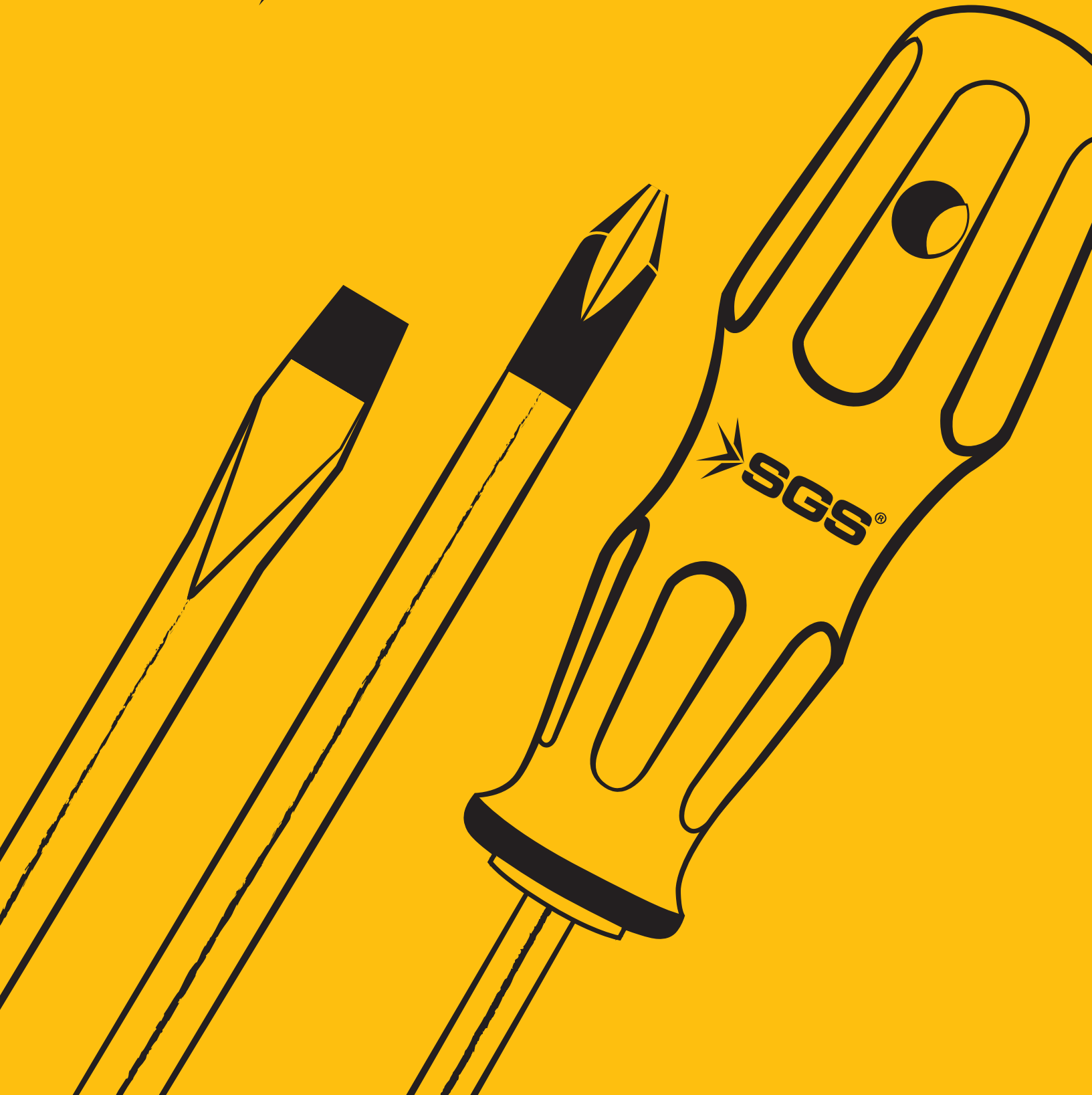

Yellow Series



Cr-V



Yıldız Tornavida

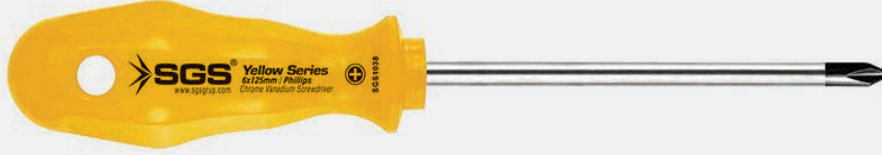

- ▶ Chrome Vanadium
- ▶ Krom Kaplama
- ▶ Sertleştirilmiş Süngü
- ▶ Yüksek Döndürme Kabiliyeti

MADE IN TÜRKİYE

Kutu: 12 Adet
Koli: 120 Adet

KODU	AÇIKLAMA	FİYAT
SGS1030	3x80	19 ₺
SGS1031	3x100	20 ₺
SGS1032	4x100	21 ₺
SGS1033	4x125	23 ₺
SGS1034	5x100	24 ₺
SGS1035	5x125	25 ₺
SGS1036	5x150	26 ₺
SGS1037	6x100	25 ₺
SGS1038	6x125	26 ₺
SGS1039	6x150	28 ₺

Yellow Series



Cr-V



Düz Tornavida



- ▶ Chrome Vanadium
- ▶ Krom Kaplama
- ▶ Sertleştirilmiş Süngü
- ▶ Yüksek Döndürme Kabiliyeti

MADE IN TÜRKİYE

Kutu: 12 Adet
Koli: 120 Adet

KODU	AÇIKLAMA	FİYAT
SGS1020	3x80	19 ₺
SGS1021	3x100	20 ₺
SGS1022	4x100	21 ₺
SGS1023	4x125	23 ₺
SGS1024	5x100	24 ₺
SGS1025	5x125	25 ₺
SGS1026	5x150	26 ₺
SGS1027	6x100	25 ₺
SGS1028	6x125	26 ₺
SGS1029	6x150	28 ₺

Soft Series



Cr-V



Yıldız Tornavida



- ▶ Chrome Vanadium
- ▶ Krom Kaplama
- ▶ Sertleştirilmiş Süngü
- ▶ Yüksek Döndürme Kabiliyeti

MADE IN TÜRKİYE

Kutu: 12 Adet
Koli: 120 Adet

KODU	AÇIKLAMA	FİYAT
SGS1650	3x80	21 ₺
SGS1651	3x100	23 ₺
SGS1652	4x100	24 ₺
SGS1653	4x125	25 ₺
SGS1654	5x100	26 ₺
SGS1655	5x125	28 ₺
SGS1656	5x150	30 ₺
SGS1657	6x100	30 ₺
SGS1658	6x125	31 ₺
SGS1659	6x150	32 ₺
SGS1660	7x125	37 ₺
SGS1661	7x150	39 ₺
SGS1662	8x150	45 ₺
SGS1663	8x175	46 ₺

Soft Series



Cr-V



Düz Tornavida



- ▶ Chrome Vanadium
- ▶ Krom Kaplama
- ▶ Sertleştirilmiş Süngü
- ▶ Yüksek Döndürme Kabiliyeti

MADE IN TÜRKİYE

Kutu: 12 Adet
Koli: 120 Adet

KODU	AÇIKLAMA	FİYAT
SGS1630	3x80	21 ₺
SGS1631	3x100	23 ₺
SGS1632	4x100	24 ₺
SGS1633	4x125	25 ₺
SGS1634	5x100	26 ₺
SGS1635	5x125	28 ₺
SGS1636	5x150	30 ₺
SGS1637	6x100	30 ₺
SGS1638	6x125	31 ₺
SGS1639	6x150	32 ₺
SGS1640	7x125	37 ₺
SGS1641	7x150	39 ₺
SGS1642	8x150	45 ₺
SGS1643	8x175	46 ₺

Black Series



Cr-V



Lokma Tornavida Derin Uçlu



- ▶ Chrome Vanadium
- ▶ Krom Kaplama
- ▶ Sertleştirilmiş Süngü
- ▶ Yüksek Döndürme Kabiliyeti

MADE IN TÜRKİYE

Kutu: 6 Adet
Koli: 60 Adet

KODU	AÇIKLAMA	FİYAT
SGS906	6x125	55 ₺
SGS907	7x125	57 ₺
SGS908	8x125	58 ₺
SGS909	9x125	59 ₺
SGS910	10x125	61 ₺
SGS911	11x125	64 ₺
SGS912	12x125	65 ₺
SGS913	13x125	66 ₺
SGS914	14x125	68 ₺
SGS917	17x125	69 ₺

Yellow Series**7'li Tornavida Seti**

- ▶ Chrome Vanadium
- ▶ Krom Kaplama
- ▶ Sertleştirilmiş Süngü
- ▶ Yüksek Döndürme Kabiliyeti

**Cr-V**  

6x150 6x125 5x125 5x100 4x100 3x80 Kontrol Kalemi

**MADE IN TÜRKİYE** 

KODU	AÇIKLAMA	KOLİ	FİYAT
SGS1040	7'li Tornavida Seti	12	175 ₺

Soft Series**5'li Tornavida Seti**

- ▶ Chrome Vanadium
- ▶ Krom Kaplama
- ▶ Sertleştirilmiş Süngü
- ▶ Yüksek Döndürme Kabiliyeti

**Cr-V**  

6x125 6x125 5x100 5x100 4x100

**MADE IN TÜRKİYE** 

KODU	AÇIKLAMA	KOLİ	FİYAT
SGS1645	5'li Tornavida Seti	12	150 ₺

Black Series**5'li Lokma Tornavida Seti**

- ▶ Chrome Vanadium
- ▶ Krom Kaplama
- ▶ Sertleştirilmiş Süngü
- ▶ Yüksek Döndürme Kabiliyeti

**Cr-V**

 7-8-10-11-13mm

**MADE IN TÜRKİYE** 

KODU	AÇIKLAMA	KOLİ	FİYAT
SGS920	5'li Lokma Seti	12	300 ₺

Black Series**+ Cr-V****Topaç Tornavida Yıldız**

- ▶ Chrome Vanadium
- ▶ Krom Kaplama
- ▶ Sertleştirilmiş Süngü
- ▶ Yüksek Döndürme Kabiliyeti

**MADE IN TÜRKİYE** 

KODU	AÇIKLAMA	Kutu/Koli	FİYAT
SGS674	6x35 Yıldız	12/120	18 ₺

Black Series**- Cr-V****Topaç Tornavida Düz**

- ▶ Chrome Vanadium
- ▶ Krom Kaplama
- ▶ Sertleştirilmiş Süngü
- ▶ Yüksek Döndürme Kabiliyeti

**MADE IN TÜRKİYE** 

KODU	AÇIKLAMA	Kutu/Koli	FİYAT
SGS664	6x35 Düz	12/120	18 ₺

Kontrol Kalemi**110-250 Volt****MADE IN TÜRKİYE**

Toplam Boy : 190 mm
Uç kalınlığı : 0.8 mm
Uç Genişliği : 4.0 mm
Süngü Boyu : 100 mm

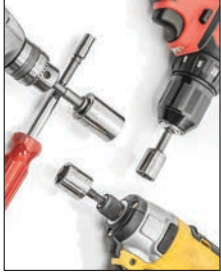

KODU	AÇIKLAMA	Paket/Koli	FİYAT
SGS725	Kontrol Kalemi	24/240	24 ₺

Lokma Adaptörü**HEX**

1/4"	3/8"	1/2"
50MM	65MM	73MM

- ▶ Sert, Güçlü ve Hassas
- ▶ Isıl İşlem Uygulanmış Karbon Çeliği



KODU	AÇIKLAMA	KOLİ	FİYAT
SGS1833	1/4''x50mm	50	0.80 \$
SGS1834	3/8''x65mm	50	1.00 \$
SGS1832	1/2''x73mm	50	1.30 \$

Lokma Adaptörü

- ▶ Sert, Güçlü ve Hassas
- ▶ Isıl İşlem Uygulanmış Karbon Çeliği



SDS	3/8"	1/2"
	60MM	65MM

KODU	AÇIKLAMA	KOLİ	FİYAT
SGS1836	3/8''x60mm	50	1.80 \$
SGS1835	1/2''x65mm	50	2.25 \$

Lokma Adaptörü 3'lü set**HEX**

1/4"	3/8"	1/2"
50MM	65MM	73MM

- ▶ Sert, Güçlü ve Hassas
- ▶ Isıl İşlem Uygulanmış Karbon Çeliği



KODU	AÇIKLAMA	KOLİ	FİYAT
SGS1837	3'lü Set	20	3.00 \$

Bits Uç Adaptörü**SDS****Manyetik Bits Uç Adaptörü**

KODU	AÇIKLAMA	PAKET	FİYAT
SGS1831	Bits Adaptör/SDSplus	25	0.80 \$



SGS[®]

Professional Hand Tools



Bağ Makası

STRONG
CUTTER BLADE

- Isıl İşlem Uygulanmış ve Bilenmiş Bıçak.
- Yüksek Basınca Dayanıklı Plastik Gövde
- Plastik Ergonomik Sap

2YIL
GARANTİ
ÜRETİM
SÜREKLİLİĞİNE KADINMADE IN
TÜRKİYE

KODU	AÇIKLAMA	Paket/Koli	FİYAT
SGS2041	Bağ Makası	6/36	6 \$

Bağ Makası

Dövme Çelik

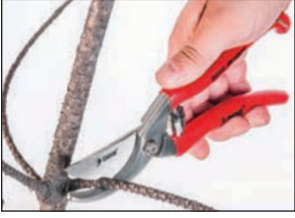
DÖVME
ÇELİKSTRONG
CUTTER BLADE

- Isıl İşlem Uygulanmış ve Bilenmiş Dövme Çelik Bıçak.
- Uzun Süreli Çalışmalar İçin Üretilmiştir Gergi Yayı.
- PVC İzoleli Ergonomik Sap

2YIL
GARANTİ
ÜRETİM
SÜREKLİLİĞİNE KADINMADE IN
TÜRKİYE

KODU	AÇIKLAMA	Paket/Koli	FİYAT
SGS2040	Bağ Makası	6/60	8 \$

Sivri Çapa



- Korozyona Karşı Elektrostatik Boyalı
- 3.00mm Kalınlığında Güçlü Metal Gövde
- 50cm Gürgen Ağaçtan Üretilmiş Ahşap Sap

2YIL
GARANTİ
ÜRETİM
SÜREKLİLİĞİNE KADINMADE IN
TÜRKİYE

KODU	AÇIKLAMA	KOLİ	FİYAT
SGS3113	Sivri Çapa	24	90 ₺
SGS3115	Sivri Çapa+Ahşap Sap	12	110 ₺

Çatal Çapa



- Korozyona Karşı Elektrostatik Boyalı
- 3.00mm Kalınlığında Güçlü Metal Gövde
- 50cm Gürgen Ağaçtan Üretilmiş Ahşap Sap

2YIL
GARANTİ
ÜRETİM
SÜREKLİLİĞİNE KADINMADE IN
TÜRKİYE

KODU	AÇIKLAMA	KOLİ	FİYAT
SGS3114	Çatal Çapa	24	90 ₺
SGS3116	Çatal Çapa+Ahşap Sap	12	110 ₺

Bahçe Seti

3 Parça
Tirmik - Çapa - Tirmik

- Yüksek Basınca Dayanıklı Plastik Gövde
- Kullanım Konforu Sağlayan Ergonomik Sap

2YIL
GARANTİ
ÜRETİM
SÜREKLİLİĞİNE KADINMADE IN
TÜRKİYE

KODU	AÇIKLAMA	KOLİ	FİYAT
SGS3120	3 Parça Bahçe Seti	6	100 ₺

Plastik Tırmık



Vidalı ve Ahşap Saplar için Uygundur

Güçlü Plastik Gövde

A	350mm
B	505mm

2YIL GARANTİ
ÜRETİM

SGS
TÜRKİYE

MADE IN TÜRKİYE

Çim artıklarını, dökülen ağaç yapraklarının toparlanmasında için tasarlanmıştır.

KODU	AÇIKLAMA	KOLİ	FİYAT
SGS3118	Plastik Tırmık	6	50 ₺

Pala Testere

Ahşap Sap
500mm



- 0.80 mm Kalınlığında Polisajlanmış 50 Rockwell Yay Çeliği
- İki Eksenli Özel Bileme
- Hızlı Kesim

2YIL GARANTİ
ÜRETİM

SGS
TÜRKİYE

MADE IN TÜRKİYE

Fast Cut Hard Point

KODU	AÇIKLAMA	KOLİ	FİYAT
SGS226	Pala Testere/500mm	6	295₺

El Testere

Ahşap Sap



- 0.80 mm Kalınlığında Polisajlanmış 50 Rockwell Yay Çeliği
- Hızlı Kesim

Fast Cut Hard Point

KODU	AÇIKLAMA	KOLİ	FİYAT
SGS222	El Testere	12	185₺

Bağ Testere

Ahşap Sap



- 0.80 mm Kalınlığında Polisajlanmış 50 Rockwell Yay Çeliği
- Hızlı Kesim

Fast Cut Hard Point

KODU	AÇIKLAMA	KOLİ	FİYAT
SGS232	Bağ Testere	12	155₺

Gaz Beton Testeresi

Elmas Uç 550mm



TUV GS
PRODUCT SERVICE

MN 65 HRC 56



- Çeliğe Kaynaklı Özel Bilenmiş Elmas Dişler
- Gaz Beton ve Tuğla Kesimi
- Yüksek Karbonlu Çelik

2YIL GARANTİ
ÜRETİM

SGS
TÜRKİYE

KODU	AÇIKLAMA	Paket/Koli	FİYAT
SGS1760	Gaz Beton Testere/ 550mm	6/24	13.50 \$

Gaz Beton Testeresi

500mm



Fast Cut Hard Point

KODU	AÇIKLAMA	KOLİ	FİYAT
SGS1759	Gaz Beton Testere/ 500mm	6	280 ₺

- ▶ 0.80 mm Kalınlığında Polisajlanmış 50 Rockwell Yay Çeligi
- ▶ Gaz Beton ve Tuğla Kesimi
- ▶ Hızlı Kesim

Budama Testeresi Kılıflı

240-270-300mm



Fast Cut Hard Point



KODU	AÇIKLAMA	Paket/Koli	FİYAT
SGS1750	240mm	6/24	6.00 \$
SGS1751	270mm	6/24	6.50 \$
SGS1752	300mm	6/24	7.00 \$

- ▶ Isıl İşlem Uygulanmış Dişler
- ▶ Yüksek Karbonlu Çelik
- ▶ Üç Eksenli Özel Bileme



Budama Testeresi Kılıflı

350mm



Fast Cut Hard Point



KODU	AÇIKLAMA	KOLİ	FİYAT
SGS1753	350mm	20	8.75 \$

- ▶ Isıl İşlem Uygulanmış Dişler
- ▶ Yüksek Karbonlu Çelik
- ▶ Üç Eksenli Özel Bileme



Budama Testeresi

300mm



Fast Cut Hard Point



KODU	AÇIKLAMA	KOLİ	FİYAT
SGS1778	300mm	12	3.00 \$

- ▶ Isıl İşlem Uygulanmış Dişler
- ▶ Yüksek Karbonlu Çelik
- ▶ Üç Eksenli Özel Bileme

Budama Testeresi Katlanır

180mm



- ▶ Isıl İşlem Uygulanmış Dişler
- ▶ Yüksek Karbonlu Çelik
- ▶ Üç Eksenli Özel Bileme

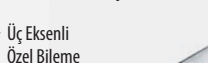

Fast Cut Hard Point



KODU	AÇIKLAMA	KOLİ	FİYAT
SGS1755	180mm	20	6.60 \$



Budama Testeresi Saptak

- ▶ Isıl İşlem Uygulanmış Dişler
- ▶ Yüksek Karbonlu Çelik
- ▶ Üç Eksenli Özel Bileme

350mm**Fast Cut**Hard Point

KODU	AÇIKLAMA	Paket/Koli	FİYAT
SGS1776	350mm	6/24	6.75 \$

Budama Testeresi 240mm**İnce Diş - Orta Diş****Fast Cut**Hard Point

- ▶ Isıl İşlem Uygulanmış Dişler
- ▶ Yüksek Karbonlu SK5 Çeliği
- ▶ Üç Eksenli Özel Bileme

KODU	AÇIKLAMA	Paket/Koli	FİYAT
SGS1761	İnce Diş	6/24	7.85 \$
SGS1765	Orta Diş	24	7.50 \$

Sırtlı Siğaçça Testeresi**300mm****Fast Cut**Hard Point

- ▶ Isıl İşlem Uygulanmış Dişler
- ▶ Yüksek Karbonlu Çelik
- ▶ Üç Eksenli Özel Bileme

KODU	AÇIKLAMA	Paket/Koli	FİYAT
SGS1770	300mm	10/40	5.00 \$

Oygu Testeresi 300mm**Fast Cut**Hard Point

- ▶ Isıl İşlem Uygulanmış Dişler
- ▶ Yüksek Karbonlu Çelik
- ▶ İki Eksenli Özel Bileme

KODU	AÇIKLAMA	Paket/Koli	FİYAT
SGS1772	300mm	6/48	4.50 \$

Alçıpan Testeresi 150mm**Fast Cut**Hard Point

- ▶ Isıl İşlem Uygulanmış Dişler
- ▶ Yüksek Karbonlu Çelik
- ▶ İki Eksenli Özel Bileme



KODU	AÇIKLAMA	Paket/Koli	FİYAT
SGS1774	150mm	10/40	4.50 \$

Demir Testere Kolu

HSS M2 / FOR METAL

- HSS M2 Yüksek Hız Çeliği
- Pozitif VARIO dişler



Kolay Montaj Sağlayan
Pimli Sistem

- 1.0 mm Kalınlığında Esnemeye Dayanıklı Profil
- Uzun Ömürlü Somunlu Kelebek



KODU	AÇIKLAMA	KOLI	FİYAT
SGS201	Boş Kol	12	100 ₺
SGS202	Testere Ağızlı Kol	12	110 ₺

Demir Testere Ağzı

HSS M2 / FOR METAL

Geniş Ağz

300x25x0,8mm



- HSS Yüksek Hız Çeliği
- Pozitif VARIO dişler
- Metal, Boru ve NE-Metallerin Manuel Kesimi



KODU	AÇIKLAMA	Paket/Koli	FİYAT
SGS206	Geniş Ağz	72/720	0.35\$

Demir Testere Ağzı

HSS M2 / FOR METAL

Dar Ağz

300x12mm



- HSS Yüksek Hız Çeliği
- Pozitif VARIO dişler
- Metal, Boru ve NE-Metallerin Manuel Kesimi



KODU	AÇIKLAMA	Paket/Koli	FİYAT
SGS207	Dar Ağz	72/720	0.25\$

Dekupaj Ağzı 5'li Set T144D Ahşap



5-50mm



Keskinleştirilmiş Testere Ağzı Hızlı ve Sert Kesim. ▶ 100mm x 7.5mm

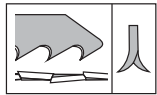

KODU	AÇIKLAMA	Paket/Koli	FİYAT
SGS2700	T144D / Ahşap	50/400	1.50 \$



Dekupaj Ağzı 5'li Set T111C Ahşap



4-50mm



Yüksek Kesme Performansıyla Sert Kesim. ▶ 100mm x 7.9mm

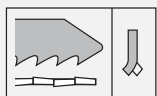

KODU	AÇIKLAMA	Paket/Koli	FİYAT
SGS2701	T111C / Ahşap	50/400	1.35 \$



Dekupaj Ağzı 5'li Set T244D Ahşap 5-50mm



5-50mm

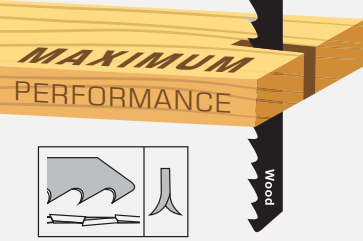

Keskinleştirilmiş Testere Ağzı Kavisli ve Sert Kesim. ▶ 100mm x 6.4mm



KODU	AÇIKLAMA	Paket/Koli	FİYAT
SGS2702	T244D / Ahşap	50/400	1.50 \$

Dekupaj Ağzı 5'li Set T101D Ahşap 10-45mm



10-45mm

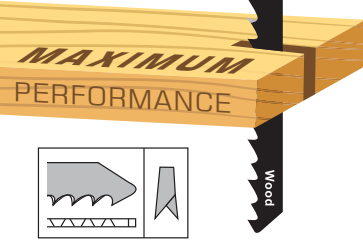

Yüksek Kesme Performansı ile Temiz Kesim. ▶ 100mm x 7.9mm



KODU	AÇIKLAMA	Paket/Koli	FİYAT
SGS2703	T101D / Ahşap	50/400	2.00 \$

Dekupaj Ağzı 5'li Set T344D Ahşap 5-75mm



5-75mm

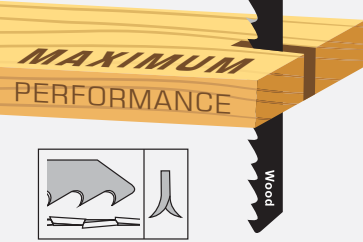

Keskinleştirilmiş Testere Ağzı Hızlı ve Sert Kesim. ▶ 150mm x 9.5mm



KODU	AÇIKLAMA	Paket/Koli	FİYAT
SGS2704	T344D / Ahşap	50/400	3.00 \$

Dekupaj Ağzı 5'li Set T127D Alüminyum

3-15mm' den kalına metal levhalar, çap 30mm borular ve profillerin kesimi için uygundur.

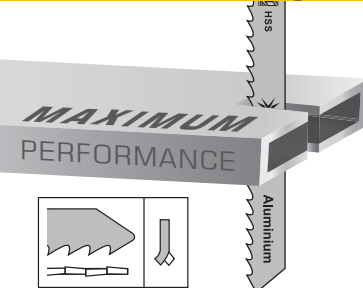

▶ Keskinleştirilmiş Testere Ağzı ▶ 100mm x 7.9mm



KODU	AÇIKLAMA	Paket/Koli	FİYAT
SGS2705	T127D / Alüminyum	50/400	4.50 \$

Dekupaj Ağzı 5'li Set T118A Metal 1-3mm' den kalına metal levhalar, kesimi için uygundur.

1-3mm' den kalına metal levhalar, kesimi için uygundur.

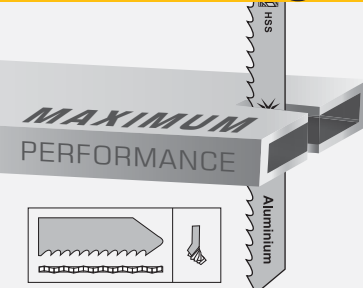

▶ Standart Testere Ağzı, Dalgalı Set, Dar Testere. ▶ 77mm x 7.9mm



KODU	AÇIKLAMA	Paket/Koli	FİYAT
SGS2706	T118A / Metal	50/400	3.00 \$

Dekupaj Ağzı 5'li Set T318A Metal

1-3mm inceden kalına metal levhalar, çap 65mm borular ve profillerin kesimi için uygundur.

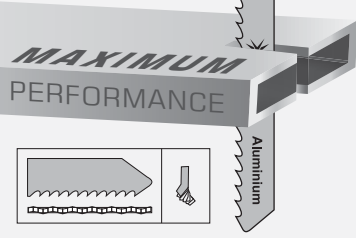

► Standart Testere Ağzı, Ekstra Uzun, Dalgalı Set. ► 132mm x 9.5mm

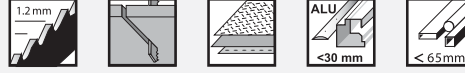

KODU	AÇIKLAMA	Paket/Koli	FİYAT
SGS2707	T318A / Metal	50 / 400	5.00 \$

**Tilki Kuyruğu 5'li Set S1531L Ahşap**240mm/5mm
9 1/2" / 5TPI

Yüksek Kesme Performansı ile Çapraz ve Frezelenmiş Dişler.

Kaba kesimler için idealdir.
Ahşapların hızlı kesimi,
ağaçların kesimi ve budaması
için uygundur.

KODU	AÇIKLAMA	Kutu /Koli	FİYAT
SGS2711	S1531L / Ahşap	20 / 100	8.00 \$

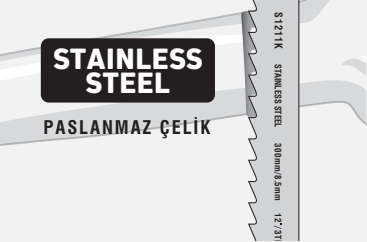
**Tilki Kuyruğu 5'li Set S1211K Paslanmaz**300mm/8.5mm
12" / 3TPI

Kemik Kesimi Uygundur.

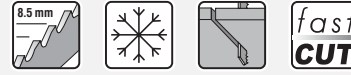
300mm Paslanmaz
tilki kuyruğu bıçağı
kemik, ahşap, metal,
pvc ve plastik
kesimi için uygundur.

KODU	AÇIKLAMA	Kutu /Koli	FİYAT
SGS2720	S1211K	10 / 100	10.00 \$

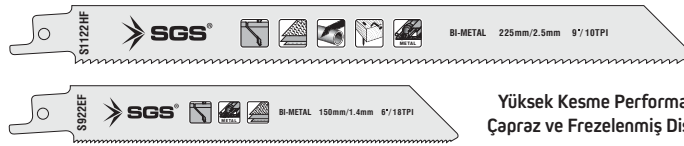
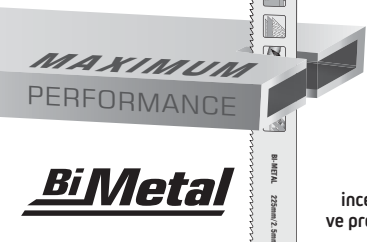
**Tilki Kuyruğu 5'li Set S922EF - S1122HF Metal**150mm x 1.4mm
225mm x 2.5mmYüksek Kesme Performansı
Çapraz ve Frezelenmiş Dişler.1,5 - 4,0 mm
malzeme kalınlığında
ince kaplama, tam borular
ve profiller Ø 5.0-100.0 mm

KODU	AÇIKLAMA	Kutu /Koli	FİYAT
SGS2712	S922EF /Metal/150mmx1.4mm	20 / 100	7.00 \$
SGS2713	S1122HF/Metal/225mmx2.5mm	20 / 100	8.25 \$

**Tilki Kuyruğu Gaz Beton-Tuğla**EXTRA
STRONG

HARDPOINT

LONG
LIFE

HM/CT

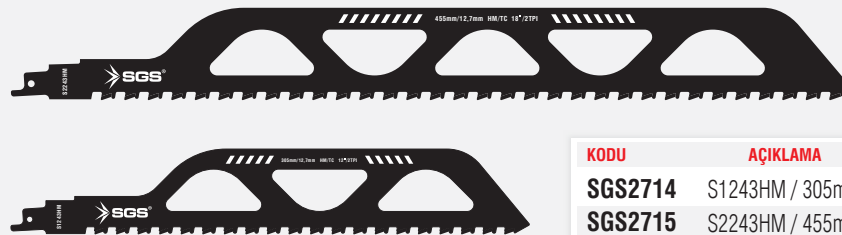
fast
CUT305mm
455mmYüksek Kesme
Performansı
Tuğla, Briket, Ytong
kesimi için uygundur.

KODU	AÇIKLAMA	Kutu /Koli	FİYAT
SGS2714	S1243HM / 305mm	25 / 100	13.50 \$
SGS2715	S2243HM / 455mm	25 / 100	17.50 \$



SGS[®]

Professional Hand Tools

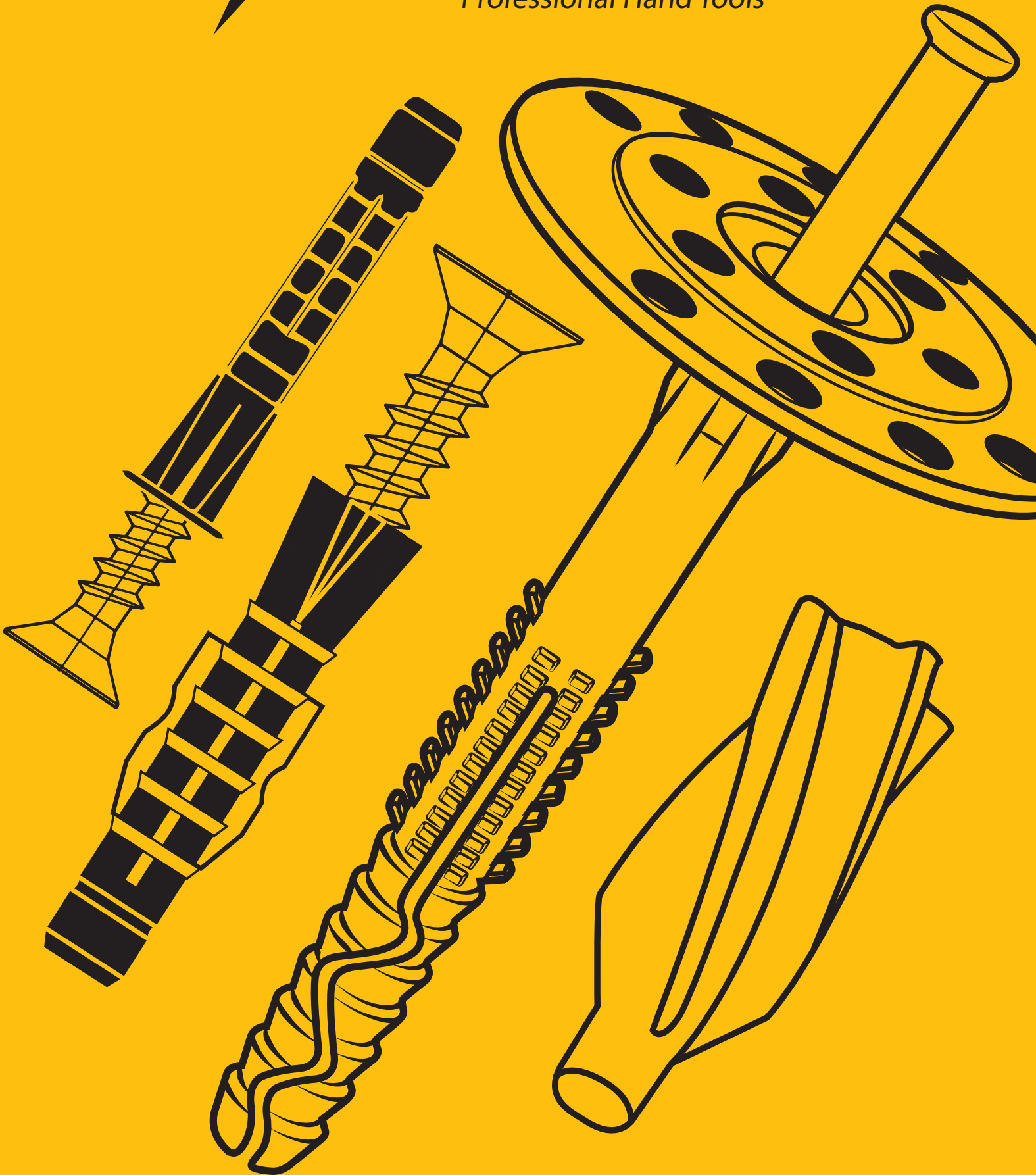

Standart Dübel

6-7-8-10-12-14mm



Standart Dübel:
Geniş kanatlar ve derin tırnaklar, montajda dönmeyi önler, yüksek mukavemet sağlar.

MADE IN TÜRKİYE



Beton



Doğal Taş



Tuğla

KODU	AÇIKLAMA	Paket/Adet	Çuval/Paket	Paket/Fiyat
SGS6100	6mm	1.000	50	115 ₺
SGS6101	7mm	1.000	25	120 ₺
SGS6102	8mm	1.000	25	124 ₺
SGS6103	10mm	500	20	132 ₺
SGS6104	12mm	500	20	312 ₺
SGS6105	14mm	250	20	355 ₺

Standart Dübel Kutulu

6-8-10-12mm



Beton



Doğal Taş



Tuğla

Standart Dübel: Geniş kanatlar ve derin tırnaklar, montajda dönmeyi önler, yüksek mukavemet sağlar.

MADE IN TÜRKİYE

KODU	AÇIKLAMA	Kutu/Adet	Koli/Kutu	Kutu/Fiyat
SGS6080	6mm	100	100	23 ₺
SGS6081	8mm	100	100	24 ₺
SGS6082	10mm	50	100	26 ₺
SGS6083	12mm	25	100	28 ₺

Tuğla Boşluk Dübel

8-10-12mm

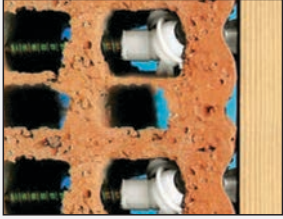

Tuğla Boşluk Dübel:
Geniş kanatlar ve derin tırnaklar, montajda dönmeyi önler, yüksek mukavemet sağlar.

MADE IN TÜRKİYE



Beton



Doğal Taş



Tuğla



KODU	AÇIKLAMA	Paket/Adet	Çuval/Paket	Paket/Fiyat
SGS6110	8mm	500	50	170 ₺
SGS6111	10mm	500	25	230 ₺
SGS6112	12mm	250	25	255 ₺

Roket Dübel

8-10mm



Roket Dübel:
Geniş kanatlar ve derin tırnaklar, montajda dönmeyi önler, yüksek mukavemet sağlar.

MADE IN TÜRKİYE



Beton



Doğal Taş



Tuğla

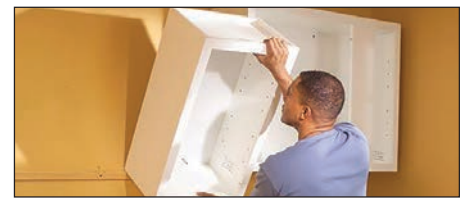

KODU	AÇIKLAMA	Paket/Adet	Çuval/Paket	Paket/Fiyat
SGS6130	8mm	500	25	143 ₺
SGS6131	10mm	500	25	230 ₺

Premium Dübel 8mm

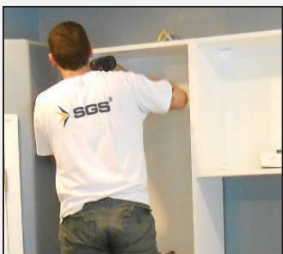

Premium Dübel:
Geniş kanatlar ve derin tırnaklar, montajda dönmeyi önler, yüksek mukavemet sağlar.

MADE IN TÜRKİYE



Beton



Doğal Taş



Tuğla

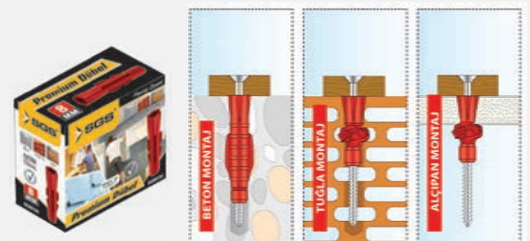

KODU	AÇIKLAMA	Kutu/Adet	Koli/Kutu	Kutu/Fiyat
SGS6134	8mm	200	40	116 ₺

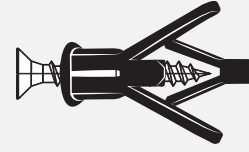
Alçıpan Dübel Kanatlı**2-3mm****MADE IN TÜRKİYE****Kanatlı Alçıpan Dübel:**

Alçıpan duvar, ahşap vb. ince duvar bağlantılarında kullanılan plastik bir dübeldir. Özel kanat yapısı ile uygulandığı noktada güvenli bir bağlantı yapar.

KODU	AÇIKLAMA	Paket/Adet	Çuval/Paket	Paket/Fiyat
SGS6135	2mm	500	30	230 ₺
SGS6136	3mm	500	30	255 ₺

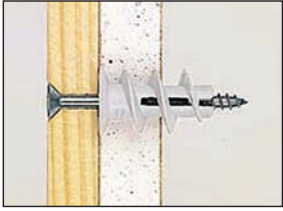
Turbolet Dübel**Matkrep-Düz Uç****Turbolet Dübel:**

Her çeşit alçıpan yapı malzemeleri montajına uygunluk sağlar. Kafa kısmındaki vida girişi sayesinde montajı son derece pratiktir.

**MADE IN TÜRKİYE****Turbolet Matkrep Uçlu Dübel**

KODU	AÇIKLAMA	Paket/Adet	Çuval/Paket	Paket/Fiyat
SGS6140	13mm	500	25	282 ₺

Turbolet Düz Uçlu Dübel

KODU	AÇIKLAMA	Paket/Adet	Çuval/Paket	Paket/Fiyat
SGS6141	12mm	250	50	270 ₺

Turbolet Çelik Dübel**Kısa - Uzun**

Delmeden yüzeye direkt olarak uygulama yapılır. Alçıpan, ytong, plastik, sunta gibi yüzeyler için uygundur.

MADE IN TÜRKİYE

KODU	AÇIKLAMA	Kutu/Adet	Koli/Kutu	Kutu/Fiyat
SGS6142	Kısa / 28mm	100	10	170 ₺
SGS6143	Uzun / 40mm	100	10	236 ₺

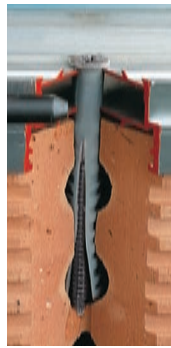
Siding Dübel**8-10mm**

Beton



Doğal Taş



Tuğla

Siding Dübel: Pencere ve Kapı Çerçevesi, Metal Profiller, Paneller, Raf, Siding Kaplama Cephe, Ahşap çıta, Kare biçimli kereste girişleri

MADE IN TÜRKİYE

KODU	AÇIKLAMA	Paket/Adet	Çuval/Paket	Paket/Fiyat
SGS6116	8x100mm	250	50	160 ₺
SGS6117	10x80mm	100	50	160 ₺
SGS6118	10x100mm	100	50	165 ₺
SGS6119	10x120mm	100	40	200 ₺

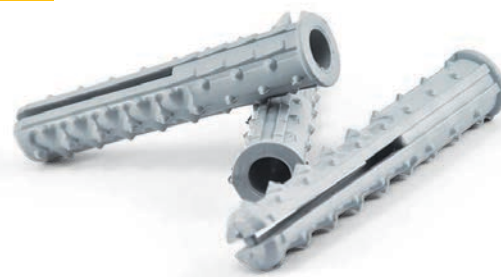
Ağır Yük Dübeli 16x90mm**EXTRA STRONG****MADE IN TÜRKİYE**

Delinatör ve Kasis malzemeleri asfalta montajında kullanılır.

KODU	AÇIKLAMA	Paket/Adet	Çuval/Paket	Paket/Fiyat
SGS6115	16x90mm	100	25	230 ₺

Gaz Beton Dübeli**8-10mm****MADE IN TÜRKİYE** **Kanatlı Alçıpan Dübel:**

Alçıpan duvar, ahşap vb. ince duvar bağlantılarında kullanılan plastik bir dübeldir. Özel kanat yapısı ile uygulandığı noktada güvenli bir bağlantı yapar.

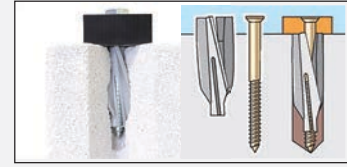

KODU	AÇIKLAMA	Paket/Adet	Çuval/Paket	Paket/Fiyat
SGS6145	8mm	100	25	205 ₺
SGS6146	10mm	100	25	225 ₺

Alçıpancı Dübel**8x34mm****Alçıpancı Dübel:**

Her çeşit alçıpan yapı malzemeleri montajına uygunluk sağlar. Geniş kanatlar ve derin tırnaklar, montajda dönmeyi önler, yüksek mukavemet sağlar.

**EXTRA STRONG****MADE IN TÜRKİYE**

KODU	AÇIKLAMA	Paket/Adet	Çuval/Paket	Paket/Fiyat
SGS6107	8x34mm	500	50	80 ₺

Çivili Dübel**7mm****Çivili Dübel**

Geniş kanatlar ve derin tırnaklar sayesinde, yüksek mukavemet sağlar. Kornişli duvar veya tuğlaya monte etmek için kullanılır.

**EXTRA STRONG****MADE IN TÜRKİYE** 

Beton



Tuğla



Gaz Beton

KODU	AÇIKLAMA	Paket/Adet	Çuval/Paket	Paket/Fiyat
SGS6170	7mm	500	25	230 ₺

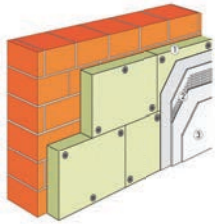
Strafor Dübeli**100-120mm**

► Kırılmalara karşı Dayanıklı Yüksek Yoğunluklu Ham Madde

► Yanlarda bulunan tırnaklar duvar içi dönmeleri en asgariye indirir.

EXTRA STRONG**MADE IN TÜRKİYE**

KODU	AÇIKLAMA	Paket/Adet	Çuval/Paket	Paket/Fiyat
SGS6150	100mm	500		600 ₺
SGS6151	120mm	500		720 ₺

Kroşe Çelik Çivili**MADE IN TÜRKİYE** **EXTRA STRONG**

KODU	AÇIKLAMA	Kutu/Adet	Koli/Kutu	Kutu/Fiyat
SGS6090	No:0 4mm Yassı Kroşe	100	200	35 ₺
SGS6091	No:1 4mm Kordon Kroşe	100	200	35 ₺
SGS6092	No:2 6mm Data Kabloları	100	200	35 ₺
SGS6093	No:3 7mm 2x1,5-3x1,5TR	100	200	50 ₺
SGS6094	No:4 8mm 2x4 Antigron	100	200	50 ₺
SGS6095	No:5 10mm 2x4 4x4 Antigron	100	100	70 ₺
SGS6096	No:6 12mm 4x6 Antigron	100	100	70 ₺
SGS6097	No:7 16mm 4x6 Antigron	100	30	125 ₺
SGS6098	No:8 25mm 4x16 Antigron	100	20	145 ₺

Kablo Kanalı Yapışkan Bantlı



Elektrik kablolarının güvenli bir şekilde korunmasında ve duvara sabitlenmesinde kullanılır.



**EXTRA
STRONG**



**MADE IN
TÜRKİYE**

KODU	AÇIKLAMA	KOLİ	FİYAT
SGS3520	12 x 12mm	320 Metre	12.00₺
SGS3528	15 x 10mm	300 Metre	13.50₺
SGS3521	16 x 16mm	250 Metre	13.50₺
SGS3527	20 x 10mm	240 Metre	18.00₺
SGS3522	25 x 16mm	154 Metre	22.00₺
SGS3523	25 x 25mm	96 Metre	29.00₺
SGS3531	40 x 16mm	84 Metre	36.00₺
SGS3524	40 x 25mm	80 Metre	41.00₺
SGS3525	40 x 40mm	72 Metre	53.00₺
SGS3526	60 x 40mm	48 Metre	76.00₺

Menfez Banyo/Wc

Tüm Hava Tahliye Kanallarında Kullanılır.



**EXTRA
STRONG**

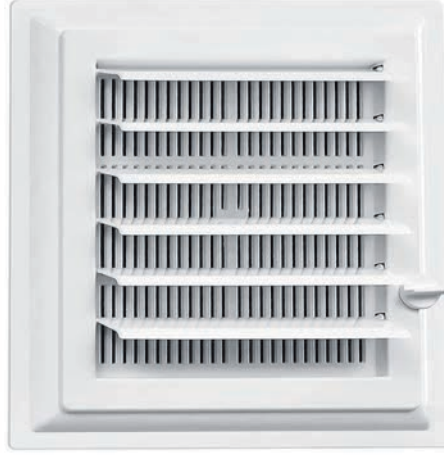

**MADE IN
TÜRKİYE**

KODU	AÇIKLAMA	KOLİ	FİYAT
SGS6230	25 x 45cm	20	145 ₺
SGS6231	30 x 30cm	20	145 ₺
SGS6232	35 x 35cm	20	150 ₺
SGS6233	35 x 45cm	20	170 ₺
SGS6234	40 x 40cm	20	170 ₺
SGS6235	45 x 45cm	20	210 ₺
SGS6236	45 x 55cm	20	240 ₺
SGS6237	45 x 65cm	20	270 ₺
SGS6238	50 x 50cm	20	275 ₺

Baca Kapağı

Dönerli



**EXTRA
STRONG**



**MADE IN
TÜRKİYE**

► Baca deliklerinin kapatılarak dekoratif görünmesini sağlar.

KODU	AÇIKLAMA	KOLİ	FİYAT
SGS6179	Beyaz	100	15 ₺

Cam Menfezi

Ø 175mm



**EXTRA
STRONG**



**MADE IN
TÜRKİYE**

► Kombinein bulunduğu alandaki cama takılır, temiz hava girişi sağlar.

KODU	AÇIKLAMA	KOLİ	FİYAT
SGS6178	Şeffaf	100	30 ₺



MAXIMUM
PERFORMANCE

SDS



Plus

130°



Matkap Ucu SDS Plus Drill Bit



SGS[®]

Professional Hand Tools

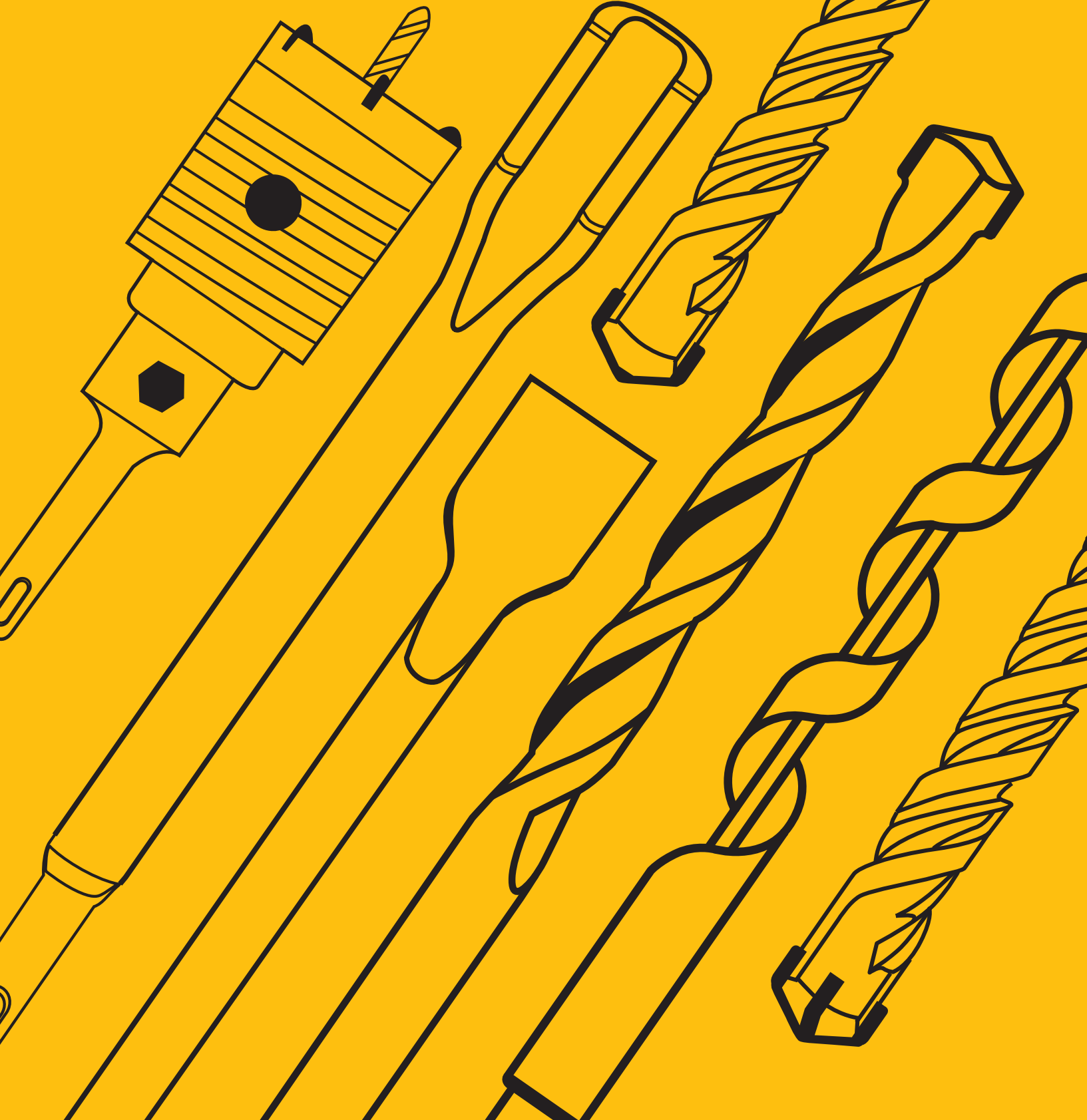



Beton Matkap Ucu

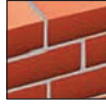

Elmas
Uç

SDS Plus



Beton, gaz beton, taş, tuğla ve benzeri malzemeye güvenli ve hızlı delme imkanı verir. Matkap deliğinin dibinde tıkanmayı engellemek için tozu doğrudan kanala iletir.



SDS Plus

110mm Matkap Ucu

KODU	AÇIKLAMA	Paket/Koli	FİYATI
SGS1500	5x110mm	20/200	0.78 \$
SGS1501	6x110mm	20/200	0.81 \$
SGS1502	7x110mm	20/200	0.85 \$
SGS1503	8x110mm	20/200	0.87 \$
SGS1504	9x110mm	20/200	0.90 \$
SGS1505	10x110mm	20/200	1.03 \$
SGS1506	11x110mm	20/200	1.19 \$
SGS1507	12x110mm	20/200	1.25 \$

SDS Plus

160mm Matkap Ucu

KODU	AÇIKLAMA	Paket/Koli	FİYATI
SGS1510	5x160mm	20/200	0.80 \$
SGS1511	6x160mm	20/200	0.82 \$
SGS1512	7x160mm	20/200	0.92 \$
SGS1513	8x160mm	20/200	0.95 \$
SGS1514	9x160mm	20/200	1.19 \$
SGS1515	10x160mm	20/200	1.22 \$
SGS1516	11x160mm	20/200	1.25 \$
SGS1517	12x160mm	20/200	1.29 \$
SGS1518	13x160mm	20/200	1.73 \$
SGS1519	14x160mm	20/200	1.78 \$

SDS Plus

210mm Matkap Ucu

KODU	AÇIKLAMA	Paket/Koli	FİYATI
SGS1520	5x210mm	20/200	1.08 \$
SGS1521	6x210mm	20/200	1.09 \$
SGS1522	7x210mm	20/200	1.10 \$
SGS1523	8x210mm	20/200	1.11 \$
SGS1524	9x210mm	20/200	1.36 \$
SGS1525	10x210mm	20/200	1.36 \$
SGS1526	11x210mm	20/200	1.47 \$
SGS1527	12x210mm	20/200	1.50 \$
SGS1528	13x210mm	20/200	1.99 \$
SGS1529	14x210mm	20/200	2.02 \$
SGS1530	16x210mm	20/200	2.34 \$

SDS Plus

350mm Matkap Ucu

KODU	AÇIKLAMA	Paket/Koli	FİYATI
SGS1540	8x350mm	50/100	1.73 \$
SGS1541	10x350mm	50/100	1.84 \$
SGS1542	12x350mm	50/100	1.97 \$
SGS1543	14x350mm	50	2.75 \$
SGS1544	16x350mm	25/50	3.17 \$
SGS1545	18x350mm	25/50	4.08 \$
SGS1546	20x350mm	25/50	5.10 \$
SGS1547	22x350mm	50	5.95 \$
SGS1548	24x350mm	50	7.39 \$
SGS1549	26x350mm	50	8.60 \$

SDS Plus

450mm Matkap Ucu

KODU	AÇIKLAMA	Paket/Koli	FİYATI
SGS1550	8x450mm	50/100	2.50 \$
SGS1551	10x450mm	50/100	2.65 \$
SGS1552	12x450mm	50	2.72 \$
SGS1553	14x450mm	50	3.55 \$
SGS1554	16x450mm	25/50	4.05 \$
SGS1555	18x450mm	25/50	5.12 \$
SGS1556	20x450mm	25	6.43 \$
SGS1557	22x450mm	25	7.38 \$
SGS1558	24x450mm	25	9.41 \$
SGS1559	26x450mm	25	10.70 \$
SGS1560	28x450mm	20	11.92 \$

SDS Plus

600mm Matkap Ucu

KODU	AÇIKLAMA	KOLİ	FİYATI
SGS1561	12x600mm	50	3.43 \$
SGS1562	14x600mm	50	4.68 \$
SGS1563	16x600mm	25	5.36 \$
SGS1564	18x600mm	25	7.05 \$
SGS1565	20x600mm	25	8.50 \$
SGS1566	22x600mm	25	9.65 \$
SGS1567	24x600mm	20	12.18 \$
SGS1568	26x600mm	10	13.86 \$
SGS1569	28x600mm	10	15.50 \$

Keski**SDS Plus**

- ▶ Tavlanmış Yüksek Çelik Kalitesi
- ▶ Güçlü Kazıma ve Kırma
- ▶ Her türlü Taş, Beton, Granit, Seramik, Asfalt, Mermer

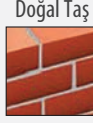
Ø14x250x22mm**EXTRA STRONG**

KODU	AÇIKLAMA	Kutu/Koli	FIYATI
SGS1570	Keski / Ø14x250x22mm	10/80	1.70 \$

Geniş Keski**SDS Plus**

- ▶ Tavlanmış Yüksek Çelik Kalitesi
- ▶ Güçlü Kazıma ve Kırma
- ▶ Her türlü Taş, Beton, Granit, Seramik, Asfalt, Mermer

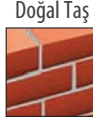
Ø14x250x40mm**EXTRA STRONG**

KODU	AÇIKLAMA	Kutu/Koli	FIYATI
SGS1572	Geniş Keski / Ø14x250x40mm	10/80	2.30 \$

Murç**SDS Plus**

- ▶ Tavlanmış Yüksek Çelik Kalitesi
- ▶ Güçlü Kazıma ve Kırma
- ▶ Her türlü Taş, Beton, Granit, Seramik, Asfalt, Mermer

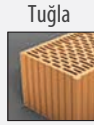
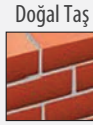
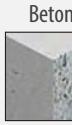
Ø14x250mm**EXTRA STRONG**

KODU	AÇIKLAMA	Kutu/Koli	FIYATI
SGS1571	Murç / Ø14x250mm	10/80	1.70 \$

Oluklu Keski**SDS Plus**

- ▶ Tavlanmış Yüksek Çelik Kalitesi
- ▶ Güçlü Kazıma ve Kırma
- ▶ Her türlü Taş, Beton, Granit, Seramik, Asfalt, Mermer

Ø14x250x22mm**EXTRA STRONG**

KODU	AÇIKLAMA	Kutu/Koli	FIYATI
SGS1573	Oluk Keski / Ø14x250x22mm	10/80	2.20 \$



Beton Matkap Ucu



Elmas
Uç



SDS Max

Beton, gaz beton, taş, tuğla ve benzeri malzemeye güvenli ve hızlı delme imkanı verir. Matkap deliğinin dibinde tıkanmayı engellemek için tozu doğrudan kanala iletir.

SDS Max

340mm Matkap Ucu

KODU	AÇIKLAMA	KOLİ	FİYATI
SGS1600	10x340mm	50	6.30 \$
SGS1601	12x340mm	50	6.35 \$
SGS1602	14x340mm	50	6.75 \$
SGS1603	16x340mm	50	7.00 \$
SGS1604	18x340mm	50	7.45 \$
SGS1605	20x340mm	25	8.25 \$
SGS1606	22x340mm	25	9.75 \$
SGS1607	24x340mm	25	10.90 \$
SGS1608	26x340mm	25	13.20 \$
SGS1609	28x340mm	25	15.70 \$

SDS Max

540mm Matkap Ucu

KODU	AÇIKLAMA	KOLİ	FİYATI
SGS1610	14x540mm	25	10.25 \$
SGS1611	16x540mm	25	10.50 \$
SGS1612	18x540mm	25	11.25 \$
SGS1613	20x540mm	25	11.85 \$
SGS1614	22x540mm	25	13.50 \$
SGS1615	24x540mm	20	15.50 \$

SDS Max

570mm Matkap Ucu

KODU	AÇIKLAMA	KOLİ	FİYATI
SGS1616	26x570mm	20	20.40 \$
SGS1617	28x570mm	10	21.50 \$
SGS1618	30x570mm	10	23.20 \$
SGS1619	32x570mm	10	27.25 \$
SGS1620	34x570mm	10	35.50 \$
SGS1621	36x570mm	10	41.30 \$
SGS1622	38x570mm	5	46.30 \$
SGS1623	40x570mm	5	47.40 \$

Adaptör



SDS Max



SDS Plus

SDS max Şafttan SDS plus Şafta Geçiş Kırıcılarına yönelik Matkap Ucu Adaptörü, SDS max şafttan SDS plus matkap uçlarına geçişe olanak sağlar

Yüksek Çalışma kapasitesi



EXTRA
STRONG

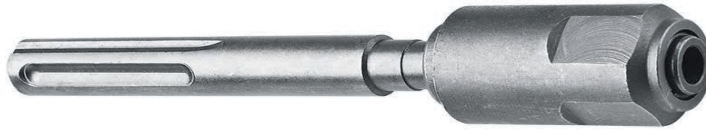

SDS Max / SDS Plus Adaptör

KODU	AÇIKLAMA	KOLİ	FİYATI
SGS1584	Adaptör / SDS Max-SDS Plus	25	13.50 \$

Adaptör



SDS Plus

SDS Plus kırıcı delicilere, otomatik ve anahtarlı mandren bağlantısı sağlar.

Yüksek Çalışma kapasitesi



EXTRA
STRONG



SDS Plus Adaptör Mandren

KODU	AÇIKLAMA	Kolu / Koli	FİYATI
SGS1580	SDS Plus Adaptör 1/2"	25 / 400	0.75 \$

Keski

SDS Max

- ▶ Tavlanmış Yüksek Çelik Kalitesi
- ▶ Güçlü Kazıma ve Kırma
- ▶ Her türlü Taş, Beton, Granit, Seramik, Asfalt, Mermer



Ø18x400x25mm
Ø18x600x25mm

EXTRA
STRONG

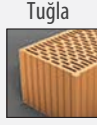
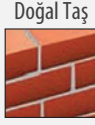
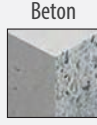

KODU	AÇIKLAMA	KOLİ	FIYATI
SGS1574	Keski / Ø18x400x25mm	25	4.45 \$
SGS1576	Keski / Ø18x600x25mm	20	6.25 \$



Geniş Keski

SDS Max

- ▶ Tavlanmış Yüksek Çelik Kalitesi
- ▶ Güçlü Kazıma ve Kırma
- ▶ Her türlü Taş, Beton, Granit, Seramik, Asfalt, Mermer



Ø18x400x40mm
Ø18x600x40mm

EXTRA
STRONG



KODU	AÇIKLAMA	KOLİ	FIYATI
SGS1578	Keski / Ø18x400x40mm	25	5.00 \$
SGS1579	Keski / Ø18x600x40mm	20	6.90 \$



Extra Geniş Keski

SDS Max

Ø18x400x75mm



EXTRA
STRONG



- ▶ Tavlanmış Yüksek Çelik Kalitesi
- ▶ Güçlü Kazıma ve Kırma

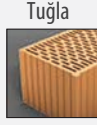
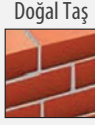
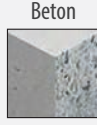

- ▶ Her türlü Taş, Beton, Granit, Seramik, Asfalt, Mermer

KODU	AÇIKLAMA	KOLİ	FIYATI
SGS1585	Keski / Ø18x400x75mm	20	7.25 \$



Murç

SDS Max

- ▶ Tavlanmış Yüksek Çelik Kalitesi
- ▶ Güçlü Kazıma ve Kırma
- ▶ Her türlü Taş, Beton, Granit, Seramik, Asfalt, Mermer



EXTRA
STRONG



Ø18x400/Ø18x600



KODU	AÇIKLAMA	KOLİ	FIYATI
SGS1575	Murç / Ø18x400	25	4.45 \$
SGS1577	Murç / Ø18x600	20	6.25 \$



Beton Buat Açma Seti

SDS Plus



EXTRA
STRONG

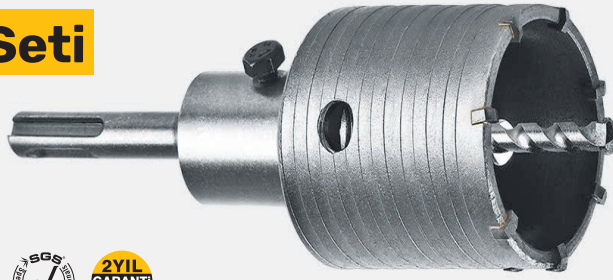

Beton, gaz beton, taş, tuğla güvenli ve hızlı delme imkanı verir.

Beton



Doğal Taş



Tuğla



Kesici
Elmas Dişler

KODU	AÇIKLAMA	Paket/Koli	FİYATI
SGS1421	30mm	5/20	6.00 \$
SGS1422	35mm	5/20	6.50 \$
SGS1423	40mm	5/20	7.00 \$
SGS1424	45mm	5/20	7.20 \$
SGS1425	50mm	5/20	7.50 \$
SGS1426	55mm	5/20	7.80 \$

KODU	AÇIKLAMA	Paket/Koli	FİYATI
SGS1427	60mm	5/20	8.30 \$
SGS1428	65mm	5/20	8.65 \$
SGS1429	70mm	5/20	9.20 \$
SGS1430	75mm	5/20	10.20 \$
SGS1431	80mm	5/20	10.90 \$
SGS1432	85mm	5/10	13.00 \$

KODU	AÇIKLAMA	Paket/Koli	FİYATI
SGS1433	90mm	2/8	14.50 \$
SGS1434	95mm	2/8	15.50 \$
SGS1435	100mm	2/8	17.50 \$
SGS1436	110mm	2/8	18.75 \$
SGS1437	120mm	2/8	21.00 \$

Beton Buat Açma Adaptörü

SDS Plus SDS Max

EXTRA
STRONG

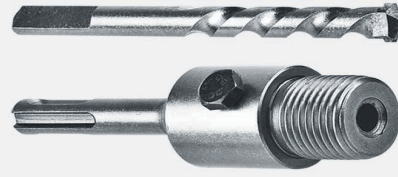

Beton buat açma aparatını matkaplarda kullanımını sağlayan adaptör.

SDS Plus 110-220-400mm

KODU	AÇIKLAMA	KOLİ	FİYATI
SGS1586	SDS Plus / 110mm	20	2.35 \$
SGS1581	SDS Plus / 250mm	25	4.30 \$
SGS1582	SDS Plus / 400mm	20	6.40 \$

SDS Max 250-400mm

KODU	AÇIKLAMA	KOLİ	FİYATI
SGS1587	SDS Max / 250mm	20	4.80 \$
SGS1583	SDS Max / 400mm	20	6.90 \$

Beton Matkap Ucu



Kesici
Elmas Uç



- ▶ Spiral Yüzey
- ▶ Tavlanmış Yüksek Çelik Kalitesi



EXTRA
STRONG



KODU	AÇIKLAMA	Paket/Koli	FİYATI
SGS1390	5x85mm	150/1200	0.38 \$
SGS1391	6x100mm	100/1000	0.45 \$
SGS1392	7x100mm	80/800	0.52 \$
SGS1393	8x120mm	60/600	0.58 \$
SGS1394	9x120mm	40/400	0.75 \$
SGS1395	10x120mm	40/400	0.82 \$
SGS1396	11x150mm	30/300	0.88 \$
SGS1397	12x150mm	30/240	0.98 \$

Beton Matkap Ucu

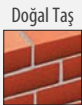

Kesici
Elmas Uç



- ▶ Spiral Yüzey
- ▶ Tavlanmış Yüksek Çelik Kalitesi



EXTRA
STRONG



KODU	AÇIKLAMA	Paket/Koli	FİYATI
SGS1405	5x85mm	100/400	0.50 \$
SGS1406	6x100mm	100/400	0.64 \$
SGS1407	7x100mm	100/400	0.72 \$
SGS1408	8x120mm	50/200	0.90 \$
SGS1409	9x120mm	50/200	1.00 \$
SGS1410	10x120mm	50/200	1.10 \$
SGS1411	11x150mm	50/200	1.20 \$
SGS1412	12x150mm	50/200	1.25 \$

Beton Matkap Uç Seti



5 Parça
5-6-7-8-10mm

EXTRA
STRONG



Kesici
Elmas Uç



- ▶ Tavlanmış Yüksek Çelik Kalitesi
- ▶ Spiral Yüzey

5 Parça / 5-6-7-8-10mm

KODU	AÇIKLAMA	Paket / Koli	FIYATI
SGS1415	5'li Beton Uç Set	5/50	3.20 \$

Ahşap Matkap Uç Seti



8 Parça
3-4-5-6-7-8-9-10mm

- ▶ Tavlanmış Yüksek Çelik Kalitesi
- ▶ Sertleştirilmiş Kesme Kenarları
- ▶ Talaş Tahliyesi Derin Oluklar
- ▶ Spiral Merkez Nokta

EXTRA
STRONG



8 Parça / 3-4-5-6-7-8-9-10mm

KODU	AÇIKLAMA	Paket / Koli	FIYATI
SGS1416	8'li Ahşap Uç Set	10/100	3.75 \$

HSS Matkap Uç Seti

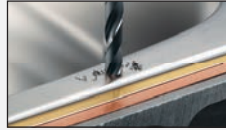

13 Parça 2-3-4-5-6mm
1.5-2.5-3.2-3.5-4.5-4.8-5.5-6.5mm



- ▶ Haddeli Yüksek Çelik Kalitesi
- ▶ Silindirik Saplı

13 Parça

1.5-2-3-3.2-3.5-4-4.5-4.8-5-5.5-6-6.5mm

KODU	AÇIKLAMA	Paket / Koli	FIYATI
SGS1417	13'lü HSS Uç Set	10/100	3.50 \$

HSS-Ahşap-Beton Matkap Uç Seti



16 Parça
6X HSS 2-3-4-5-6-8
5X Beton 5-6-7-8-10
5X Ahşap 4-5-6-8-10

EXTRA
STRONG



KODU	AÇIKLAMA	Paket / Koli	FIYATI
SGS1418	16'li Matkap Uç Set	10/50	8.50 \$

Ahşap Yaprak Matkap Uç Seti



6 Parça
10-12-16-18-20-25mm

EXTRA
STRONG



6'lı Duvar Askı Standı

Temiz bir kesim ve daha az parçalanma ile delik açmanıza yardımcı olur. Yumuşak, orta sert ahşap, sunta vb malzemelerde kullanabilirsiniz. Yüksek aşınma gücüne sahip ve uzun ömürlüdür.

KODU	AÇIKLAMA	KOLİ	FIYATI
SGS1480	6'lı Yaprak Uç Set	40	4.50 \$

HSS Matkap Ucu



► Haddeli Yüksek Çelik Kalitesi ► Silindirik Saplı ► Spiral Yüzey



KODU	AÇIKLAMA	Paket/Koli	FİYATI
SGS2800	1.0mm	10/200	0.08 \$
SGS2801	1.5mm	10/200	0.09 \$
SGS2802	2.0mm	10/200	0.09 \$
SGS2803	2.5mm	10/200	0.10 \$
SGS2804	3.0mm	10/400	0.10 \$
SGS2805	3.2mm	10/400	0.12 \$
SGS2806	3.5mm	10/400	0.13 \$
SGS2807	4.0mm	10/120	0.14 \$
SGS2808	4.2mm	10/120	0.14 \$
SGS2809	4.5mm	10/120	0.14 \$
SGS2810	5.0mm	10/100	0.17 \$

KODU	AÇIKLAMA	Paket/Koli	FİYATI
SGS2811	5.2mm	10/100	0.20 \$
SGS2812	5.5mm	10/100	0.22 \$
SGS2813	6.0mm	10/100	0.31 \$
SGS2814	6.5mm	10/100	0.32 \$
SGS2815	7.0mm	10/100	0.38 \$
SGS2816	7.5mm	10/100	0.42 \$
SGS2817	8.0mm	5/120	0.48 \$
SGS2818	8.5mm	5/120	0.54 \$
SGS2819	9.0mm	5/110	0.65 \$
SGS2820	9.5mm	5/100	0.75 \$
SGS2821	10mm	5/100	0.85 \$

KODU	AÇIKLAMA	Paket/Koli	FİYATI
SGS2822	10.5mm	5/100	0.95 \$
SGS2823	11mm	5/100	1.10 \$
SGS2824	12mm	5/100	1.38 \$
SGS2825	12.5mm	5/100	1.58 \$
SGS2826	13mm	5/100	1.65 \$
SGS2827	14mm	1/25	1.95 \$
SGS2828	15mm	1/25	2.70 \$
SGS2829	16mm	1/25	3.50 \$
SGS2830	17mm	1/25	3.80 \$
SGS2831	18mm	1/25	4.20 \$
SGS2832	20mm	1/25	4.75 \$

HSS Matkap Uç Seti

EXTRA
STRONG



19 Parça Metal Standlı Kutu

1-2-3-4-5-6-7-8-9-10mm
1.5-2.5-3.5-4.5-5.5-6.5-7.5-8.5-9.5mm



KODU	AÇIKLAMA	KOLİ	FİYATI
SGS1419	19'lu HSS Uç Set	50	11 \$

HSS Matkap Uç Seti

EXTRA
STRONG



25 Parça Metal Standlı Kutu

1-2-3-4-5-6-7-8-9-10-11-12-13mm
1.5-2.5-3.5-4.5-5.5-6.5-7.5-8.5-9.5-10.5-11.5-12.5mm



KODU	AÇIKLAMA	KOLİ	FİYATI
SGS1420	25'li HSS Uç Set	20	17.50 \$

HSS

Kademeli

Matkap Ucu



TITANIUM COATED



Ø6-52mm / Ø4-32mm / Ø4-20mm / Ø4-12mm



KODU	AÇIKLAMA	Paket/Koli	FİYATI
SGS2841	Ø4-12mm	20/500	3.00 \$
SGS2842	Ø4-20mm	10/250	4.50 \$
SGS2843	Ø4-32mm	5/100	7.75 \$
SGS2844	Ø6-52mm	10/20	28 \$

HSS 3 Parça

Kademeli

Matkap Uç Seti

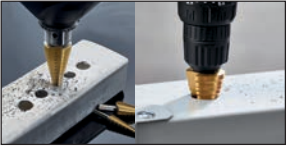

TITANIUM COATED



Ø4-32mm / Ø4-20mm / Ø4-12mm



Ø4-12mm / Ø4-20mm / Ø4-32mm

KODU	AÇIKLAMA	Paket/Koli	FİYATI
SGS2840	3'lü Set	5/20	17.50 \$

Ahşap

Matkap Ucu

SDS Plus



- ▶ Tavlanmış Yüksek Çelik Kalitesi
- ▶ Sertleştirilmiş Kesme Kenarları
- ▶ Talaş Tahliyesi Ekstra Derin Oluklar
- ▶ Spiral Merkez Nokta



SDS Plus

250mm

Ahşap Matkap Ucu

KODU	AÇIKLAMA	Paket/Koli	FİYATI
SGS1440	8x250mm	50/500	1.60 \$
SGS1441	10x250mm	50/250	1.70 \$
SGS1442	12x250mm	50/100	1.95 \$
SGS1443	14x250mm	25/100	2.35 \$
SGS1444	16x250mm	25/125	2.75 \$
SGS1445	18x250mm	50/100	3.20 \$
SGS1446	20x250mm	50/100	3.95 \$
SGS1447	22x250mm	50/100	4.50 \$
SGS1448	24x250mm	50/100	5.35 \$

SDS Plus

500mm

Ahşap Matkap Ucu

KODU	AÇIKLAMA	Paket/Koli	FİYATI
SGS1450	8x500mm	50/200	2.70 \$
SGS1451	10x500mm	50/100	2.75 \$
SGS1452	12x500mm	50/100	3.25 \$
SGS1453	14x500mm	25/50	3.85 \$
SGS1454	16x500mm	25/50	4.50 \$
SGS1455	18x500mm	25/50	5.25 \$
SGS1456	20x500mm	20/40	6.50 \$
SGS1457	22x500mm	20/40	7.95 \$
SGS1458	24x500mm	20/40	9.50 \$

Kalıpcı Ahşap

Matkap Ucu

SDS Plus 600mm



EXTRA STRONG



- ▶ Tavlanmış Yüksek Çelik Kalitesi
- ▶ Spiral Yüzey

KODU	AÇIKLAMA	Paket/Koli	FİYATI
SGS1460	10x600mm	25/50	4.75 \$
SGS1461	12x600mm	25/50	5.30 \$
SGS1462	14x600mm	25/50	5.90 \$
SGS1463	16x600mm	25/50	6.95 \$
SGS1464	18x600mm	20/40	7.30 \$
SGS1465	20x600mm	20/40	7.40 \$
SGS1466	22x600mm	20/40	8.20 \$
SGS1467	24x600mm	20/40	9.20 \$

Havşa Matkap Ucu

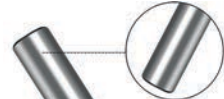

Slindirik Sap
Darbeğe Dayanıklı
Entegre Tasarım



Ayarlanabilir Uzunluk
Farklı uzunluklara göre
ayarlanabilir matkap ucu



Kesici Bıçak
Yüksek hassasiyet,
Düzensiz kesim

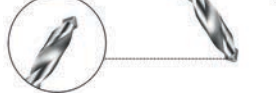

Matkap Ucu
Çapaksız Temiz Delik



**EXTRA
STRONG**
2YIL
GARANTİ
ÜRETİM

KODU	AÇIKLAMA	Paket / Koli	FIYATI
SGS1475	3mm	50/400	2.05 \$
SGS1476	3.5mm	50/400	2.05 \$
SGS1477	4mm	50/400	2.05 \$

Ayarlı Delme Pauç Seti

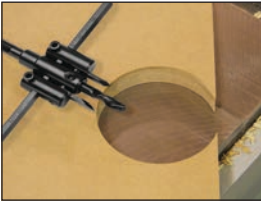

MAX
200
RPM
M2
CUTTER BLADES



- Güçlü Gövde
- Kesici Çift Bıçak Hassas ve Temiz Kesim İçin
- Kesin Konumlandırma İçin Pilot Uç
- Vidalı Kilitleme

Ø 30 - 120mm
Ø 40 - 200mm



KODU	AÇIKLAMA	KOLİ	FIYATI
SGS2185	Ø30-120mm	50	7.25 \$
SGS2186	Ø40-200mm	20	8.75 \$

Pauç Seti 7 Parça



Ø 26mm
Ø 32-38mm
Ø 45-50mm
Ø 56-63mm



MDF, Ahşap, sunta, plastik, kartonpiyer vs. gibi malzemelerde delik açmak için kullanılır.

2YIL
GARANTİ
ÜRETİM
EXTRA
STRONG



KODU	AÇIKLAMA	Paket / Koli	FIYATI
SGS2163	Pauç Seti	10/100	3.50 \$

Elmas Pauç Seti 6 Parça



33mm
53mm
67mm
73mm
83mm

2YIL
GARANTİ
ÜRETİM
EXTRA
STRONG



- Tungsten Karpit Uçlar
- Yüksek Karbon Çeliği



KODU	AÇIKLAMA	KOLİ	FIYATI
SGS2175	Pauç Seti	20	24 \$

Ayarlı Delme Aparatı

minimum
20mm
maximum
100mm



- 20 - 100mm Çap Ayarlama
- Kesin Konumlandırma İçin Pilot Uç
- Vidalı Kilitleme
- Güçlü Gövde Matkap kullanımı için

2YIL
GARANTİ
ÜRETİM
EXTRA
STRONG



KODU	AÇIKLAMA	Paket / Koli	FIYATI
SGS145	Ayarlı Delme	10/100	5.00 \$

Delme Pauç

Mermer
Granit - Taş
Kuars



M-14

EXTRA
STRONG



PREMIUM
DIAMOND
QUALITY

Vakum Lehimli
Elmas Matkap Ucu



KODU	AÇIKLAMA	Paket/Koli	FİYATI
SGS2735	M-14 / 16mm	10/100	6.80 \$
SGS2736	M-14 / 18mm	10/100	7.30 \$
SGS2737	M-14 / 20mm	10/100	7.30 \$
SGS2738	M-14 / 25mm	10/100	8.10 \$
SGS2739	M-14 / 30mm	10/100	9.65 \$
SGS2740	M-14 / 33mm	10/100	10.00 \$
SGS2741	M-14 / 35mm	10/100	11.30 \$
SGS2742	M-14 / 40mm	10/100	13.00 \$
SGS2743	M-14 / 45mm	10/100	15.00 \$
SGS2744	M-14 / 50mm	10/100	16.45 \$
SGS2745	M-14 / 55mm	10/100	18.15 \$
SGS2746	M-14 / 60mm	2/20	19.85 \$
SGS2747	M-14 / 65mm	2/20	21.55 \$

Elmas Rayba M-14

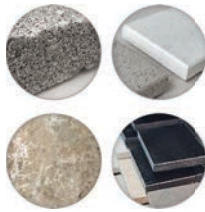

PREMIUM
DIAMOND
QUALITY

Vakum Lehimli
Elmas Matkap Ucu

EXTRA
STRONG

Mermer -Granit - Taş- Kuvars

KODU	AÇIKLAMA	Paket/Koli	FİYATI
SGS2750	M-14 / 15mm	10/100	11.05 \$
SGS2751	M-14 / 20mm	10/100	12.80 \$
SGS2752	M-14 / 25mm	10/100	15.10 \$
SGS2753	M-14 / 30mm	10/100	18.05 \$

Delme Pauç

Mermer - Granit
Taş - Kuvars

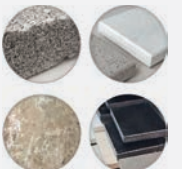

HEX

EXTRA
STRONG



PREMIUM
DIAMOND
QUALITY

Vakum Lehimli
Elmas Matkap Ucu

KODU	AÇIKLAMA	Paket/Koli	FİYATI
SGS2756	HEX / 6mm	100/1000	2.15 \$
SGS2757	HEX / 8mm	100/1000	2.15 \$
SGS2758	HEX / 10mm	100/1000	2.45 \$
SGS2759	HEX / 12mm	100/1000	2.45 \$
SGS2760	HEX / 14mm	100/1000	2.90 \$

Bi-Metal Panç

EXTRA
STRONG

HSS

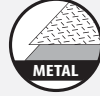

► Esnek Yay Çeliği ► Düşük Vibrasyon ► Yüksek Alışımlı HSS Dişler

4/6 TPI Değişken Atımlı Diş Tasarımı

Yassı metal, bronz, bakır, alüminyum, ahşap, plastik ve MDF vs. gibi malzemelerde delik açmak için kullanılır.



KODU	AÇIKLAMA	KOLİ	FİYATI
SGS2600	20mm	200	2.10 \$
SGS2601	22mm	200	2.30 \$
SGS2602	25mm	200	2.65 \$
SGS2603	32mm	200	3.40 \$
SGS2604	35mm	200	3.65 \$
SGS2605	41mm	100	4.27 \$
SGS2606	44mm	100	4.55 \$
SGS2607	48mm	100	5.00 \$
SGS2608	51mm	100	5.35 \$

KODU	AÇIKLAMA	KOLİ	FİYATI
SGS2609	54mm	50	5.70 \$
SGS2610	57mm	50	6.06 \$
SGS2611	60mm	50	6.30 \$
SGS2612	64mm	50	6.75 \$
SGS2613	68mm	50	7.35 \$
SGS2614	73mm	50	8.05 \$
SGS2615	83mm	50	9.55 \$
SGS2616	111mm	20	12.60 \$
SGS2617	114mm	20	14.42 \$

KODU	AÇIKLAMA	KOLİ	FİYATI
SGS2618	121mm	20	15.40 \$
SGS2619	127mm	20	16.80 \$
SGS2620	133mm	20	18.00 \$
SGS2621	140mm	20	18.40 \$
SGS2622	152mm	20	21.70 \$
SGS2623	160mm	10	22.75 \$
SGS2624	165mm	10	24.30 \$
SGS2625	168mm	10	25.40 \$
SGS2626	200mm	10	31.00 \$
SGS2627	210mm	10	32.20 \$

Bi-Metal Panç Set

13 Parça

○ HEX Adaptör 32mm x 210mm

Ø Adaptör 14mm x 30mm

Allen Anahtar

19 - 22 - 29 - 35 - 38mm

44 - 51 - 57 - 64mm



HSS

EXTRA
STRONG

KODU	AÇIKLAMA	KOLİ	FİYATI
SGS2650	Bi-Metal Panç Seti	10	55 \$

Panç

Adaptör

○ HEX Plus

Ø14mm - 30mm

Ø32mm - 210mm



KODU	AÇIKLAMA	KOLİ	FİYATI
SGS2645	Ø14mm - 30mm	100	2.00 \$
SGS2646	Ø32mm - 210mm	100	4.40 \$

Panç

Adaptör

○ SDS Plus

Ø14mm - 30mm

Ø32mm - 210mm



KODU	AÇIKLAMA	KOLİ	FİYATI
SGS2640	Ø14mm - 30mm	50	3.60 \$
SGS2641	Ø32mm - 210mm	50	5.20 \$

Panç Seti 8 Parça

► Isıl İşlem Uygulanmış Dişler ► Yüksek Karbonlu Çelik

64-76-89-102-127mm

67-127mm Adaptör - Panç Koruma Plakası-Allen Anahtar

KODU	AÇIKLAMA	KOLİ	FİYATI
SGS2160	8 Parça Panç Seti	20	6.80 \$

Panç Seti 11 Parça

► Isıl İşlem Uygulanmış Dişler ► Yüksek Karbonlu Çelik

19-25-28-32-38-44-51-64mm

2 Adet 19-64mm Adaptör - Allen Anahtar

KODU	AÇIKLAMA	KOLİ	FİYATI
SGS2161	11 Parça Panç Seti	20	5.50 \$

Panç Seti 16 Parça

► Isıl İşlem Uygulanmış Dişler ► Yüksek Karbonlu Çelik

19-22-28-32-38mm

44-51-64-76-89-102-127mm

2 Adet 12-127mm Adaptör - Panç Koruma Plakası - Allen Anahtar

KODU	AÇIKLAMA	KOLİ	FİYATI
SGS2162	16 Parça Panç Seti	20	10 \$

Çelik Tel Fırça

► Pirinç Kaplı Çelik Tel
► Çok Amaçlı Kavisli Tasarım



Dar açılı bölgeler, köşeler ve borular gibi ulaşılmaz zor yerlerde temizleme için idealdir.

KODU	AÇIKLAMA	Paket/Koli	FİYATI
SGS757	Çelik Tel Fırça / Kutulu	12/120	0.90 \$
SGS758	Çelik Tel Fırça / Blisterli	12/120	1.20 \$

Dairesel Fırça

► Pirinç Kaplı Çelik Tel
► Yüzeysel Temizleyici
► Pas Sökücü
► Boya Sökücü

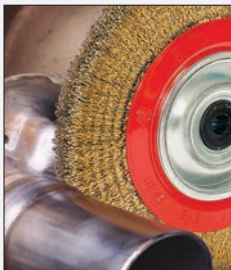
**Dairesel Fırça / Saçaklı**

KODU	AÇIKLAMA	KOLİ	FİYATI
SGS795	125mm	60	3.25 \$
SGS796	150mm	40	4.75 \$
SGS797	175mm	30	5.50 \$
SGS798	200mm	20	6.60 \$

Çanak Fırça



- ▶ Pirinç Kaplı Çelik Tel
- ▶ Yüzey Temizleyici
- ▶ Pas Sökücü
- ▶ Boya Sökücü



Çanak Fırça / Saçaklı



KODU	AÇIKLAMA	KOLİ	FİYATI
SGS785	65mm	100	1.50 \$
SGS786	80mm	100	1.60 \$
SGS787	100mm	60	2.40 \$
SGS788	125mm	60	3.75 \$

Çanak Fırça



- ▶ Burgulu Çelik Tel
- ▶ Yüzey Temizleyici
- ▶ Pas Sökücü
- ▶ Boya Sökücü



Çanak Fırça / Burgulu



KODU	AÇIKLAMA	KOLİ	FİYATI
SGS790	65mm	100	1.90 \$
SGS791	80mm	100	2.20 \$
SGS792	100mm	60	2.80 \$
SGS793	125mm	60	4.35 \$

Çanak Fırça



- ▶ Pirinç Kaplı Çelik Tel
- ▶ Yüzey Temizleyici
- ▶ Pas Sökücü
- ▶ Boya Sökücü



Çanak Fırça Pimli/Saçaklı



KODU	AÇIKLAMA	Paket /Koli	FİYATI
SGS831	50mm	10/200	0.90 \$
SGS832	65mm	10/200	1.00 \$
SGS833	80mm	5/100	1.20 \$

Dairesel Fırça



- ▶ Pirinç Kaplı Çelik Tel
- ▶ Yüzey Temizleyici
- ▶ Pas Sökücü
- ▶ Boya Sökücü



Dairesel Fırça Pimli/Saçaklı



KODU	AÇIKLAMA	Paket /Koli	FİYATI
SGS835	50mm	25/500	0.65 \$
SGS836	75mm	10/200	0.80 \$
SGS837	100mm	5/100	1.15 \$

Kalem Fırça



- ▶ Pirinç Kaplı Çelik Tel
- ▶ Yüzey Temizleyici
- ▶ Pas Sökücü
- ▶ Boya Sökücü



KODU	AÇIKLAMA	Paket /Koli	FİYATI
SGS840	12mm	40/800	0.40 \$
SGS841	16mm	20/400	0.42 \$
SGS842	19mm	15/300	0.55 \$
SGS843	25mm	10/200	0.60 \$
SGS844	30mm	10/200	0.75 \$

SATIŞ KOŞULLARI

Değerli Müşterimiz,

- ✓ Siparişlerinizin hızlı ve doğru şekilde sevki için **SGS Bayi Portalını (b2b.sgsgrup.com)** kullanınız.
- ✓ Mutabakatlarınızı en az 30 ile 90 gün içerisinde muhasebe departmanı ile muhakkak yapınız.
- ✓ İade mal, müşteri temsilcisinin veya şirket merkezinin bilgisi dahilinde olmalıdır. İade edilecek ürünün yerinde tespit edilmesi veya satış temsilcimizin şirket merkezini önceden bilgilendirmesi gerekmektedir.
- ✓ Fatura tarihinden itibaren 15 gün içerisinde kullanılmamış ve ambalajı bozulmamış mallar iade alınacaktır.
- ✓ Amacı dışında kullanılmış ve deforme olmuş malların iadesi kabul edilmeyecektir.
- ✓ Yıl içerisinde piyasa şartları göz önüne alınarak çeşitli kampanyalar yapılabilir veya yeni fiyat uygulamalarına geçilebilir. Böyle durumlarda firmamızdan geriye dönük hak ve iskonto talep edilemez.
- ✓ Firmamız haber verilmeksizin fiyat değiştirme hakkına sahiptir.
- ✓ İş bu sirkülerde belirtilen şartlar **SGS EL ALETLERİ SAN. ve TİC.LTD.ŞTİ.** ile müşterilerimiz arasında anlaşma sayılmış olup şirketimiz satış şartlarını değiştirme hakkına sahiptir.
- ✓ Fiyatlarımıza K.D.V. dahil değildir.

Hayırlı işler diler, başarılarınızın devamını temenni ederiz.







Since

1980

aynı heyecanla üretiyoruz.

FIXED®

Yapı Kimyasalları



www.sgsgroup.com - www.sgstools.com.tr